

Contents







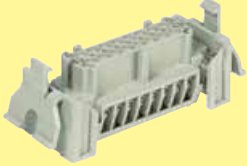

Page

Features Han-Snap®	11.02
Component range Han-Snap®	11.03
Description of parts	11.04
Latching parts without/with Strain relief and Panel mounting parts	11.06
Panel mounting	11.08
Insert mounting without/with Carrier element	11.12
Plastic housings	11.16
Accessories	11.18

Note:

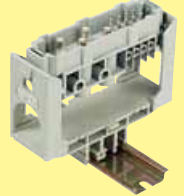
A connector mounted with Han-Snap® elements does not offer finger safe protection to the relevant standards. In this case protection against electric shock must be provided by the installation methods of the user.

- ❑ The Han-Snap® system is ideal for connectors within closed electrical operating environments. These can be rooms, cabinets or termination boxes.
- ❑ The Han-Snap® components are an innovative design which offer the following advantages and characteristics:
 - reduction of material and assembly costs;
 - fast and easy installation;
 - preassembly of Han connectors;
 - secure and rigid mounting of Han connectors;
 - frequent use of latching systems is possible (up to several thousand cycles).
- ❑ The Han-Snap® elements are compatible with the standard inserts and terminal block connectors of the following series (named series Han B as follows)
 - Han D®, 40 and 64 pins
 - Han DD®
 - Han E®
 - Han® EE
 - Han® ES
 - Han Hv E®
 - Han® Hv ES
 - Han® HsB
 - Han® HsC
 - Han-Com®
 - Han-Modular®
- ❑ With the Han-Snap® adapter the following standard inserts are compatible (named series Han A as follows):
 - Han D®, 15 and 25 pins
 - Han A®, 10 and 16 pins
- ❑ The Han-Snap® elements are a mechanical system for the mounting assembly and security of Han connectors. Normally the elements are assembled to the connector insert using the standard insert fixing screws. If coding is required the standard fixing screws may be replaced by either code pins or guide pins and bushes.
- ❑ On free connectors the wires or cables can be secured to the strain relief element with standard cable ties of 5 mm width maximum.

Figure	Han-Snap® Component	Application
	Latching parts	For free connector.
	Latching parts with strain relief	For free connector.
	Latching parts with strain relief and Panel mounting parts	For free coupling of male and female inserts.
	Plastic housings	For free connector.
	Insert mounting with carrier element	For fixing of Han connectors on standard rails, cross direction.
	Insert mounting	For fixing of Han connectors on caprail, in line.
	Fixing element	For mating of free connector with terminal block connector, whereby terminal block connector is fixed by means of the combi-fixing element on standard rail.
	Panel mounting parts	Fixing elements for fixed connectors, standard inserts or terminal block connectors, for fixing in sheet metal panel.

Han-Snap® on standard rail

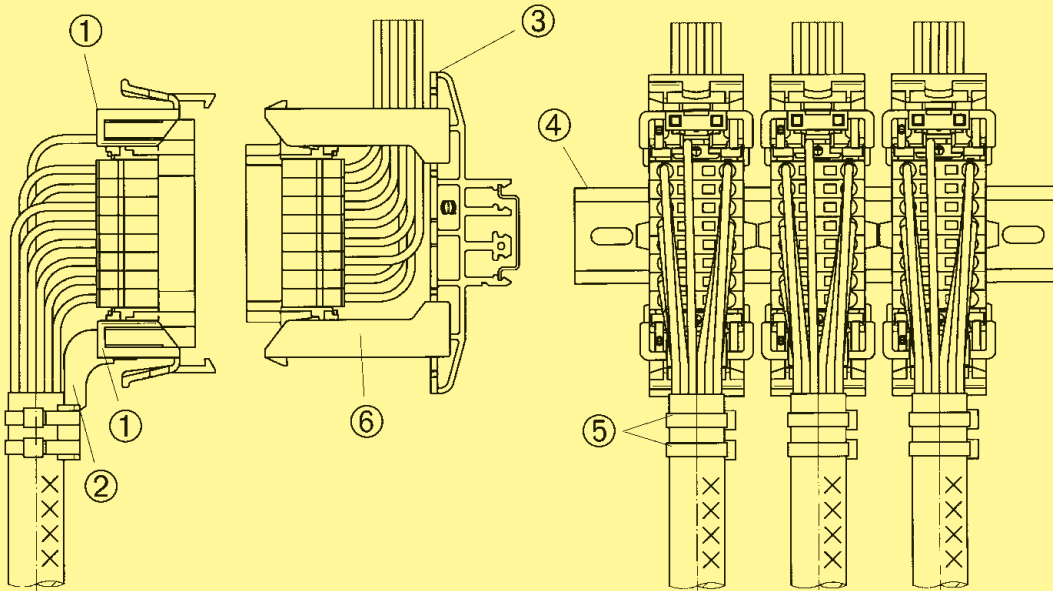

- ① Latching parts
- ② Strain relief
- ③ Carrier element
- ④ Standard rail
- ⑤ Cable tie
- ⑥ Insert mounting

Han-Snap® in Panel cut out

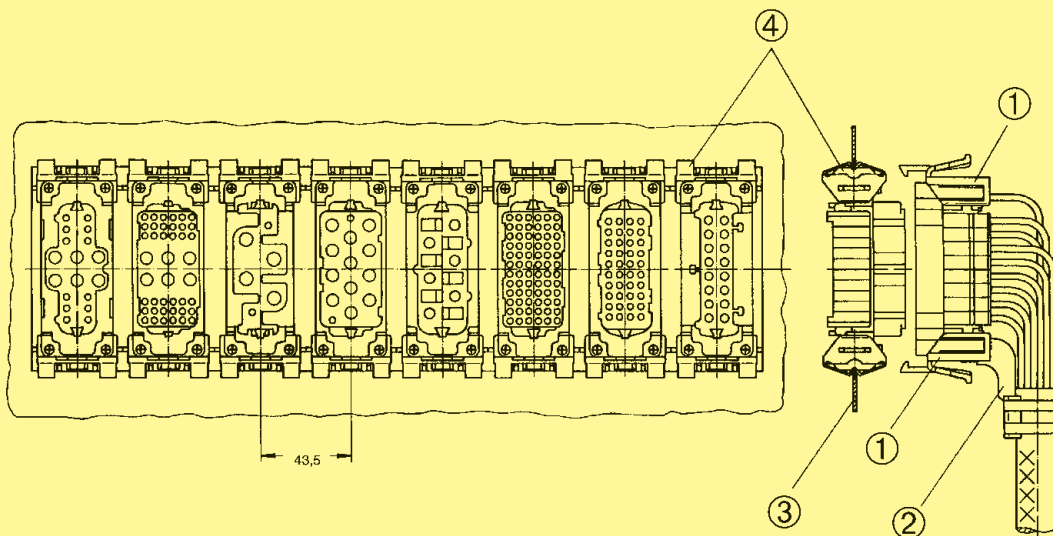

- ① Latching parts
- ② Strain relief
- ③ Assembly panel 1.3 ... 3 mm thick
- ④ Panel mounting parts

Han
Snap

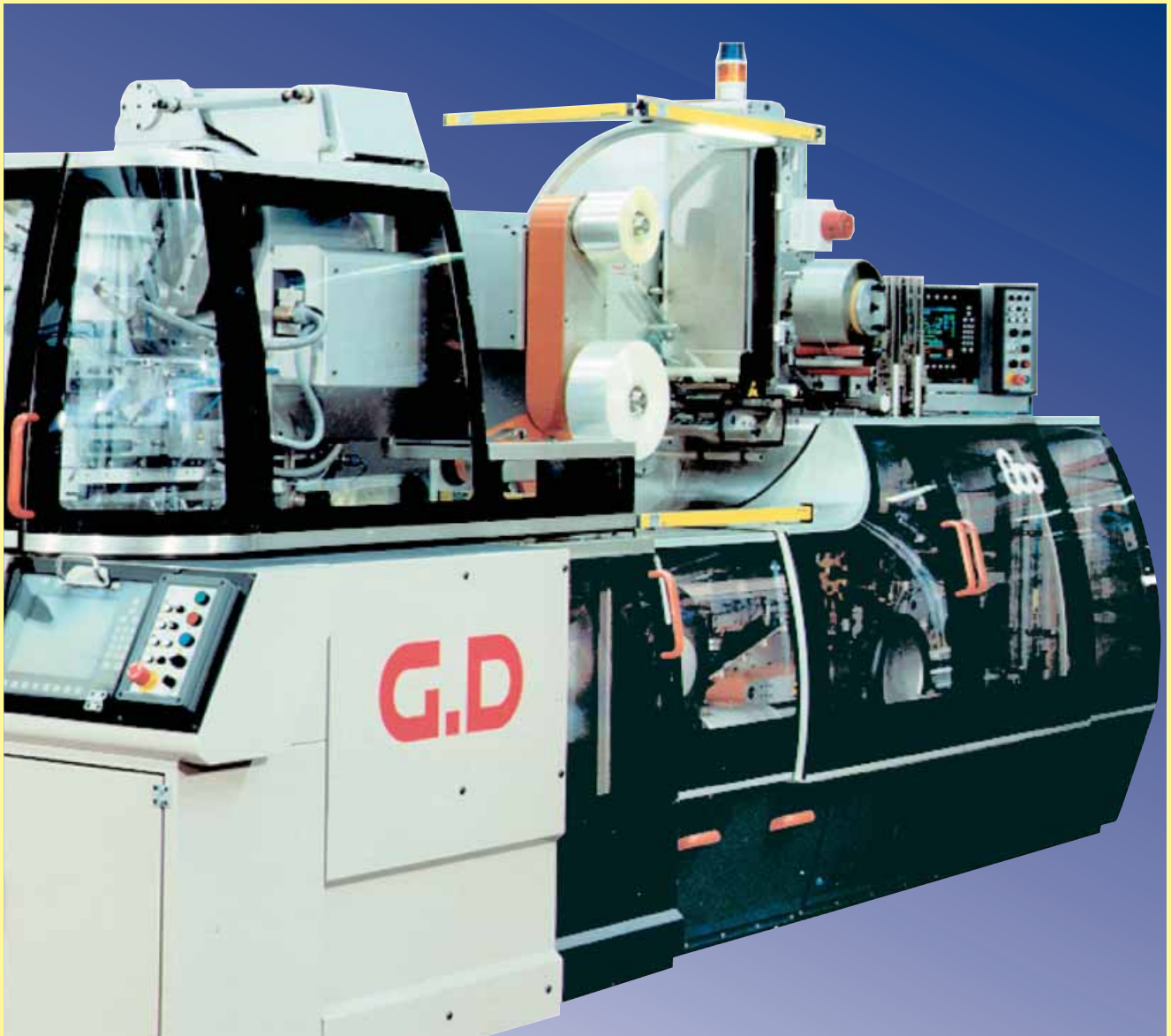

Cigarette packing machine C 800,
G. D. S. p. A., Bologna, Italy

Features

- Space saving
- Practical and easy handling
- Reduction of material and assembly costs
- For all standard Han® B inserts and terminal block connectors

Inserts can be mounted on the panel mounting part and the latching part with the standard insert mounting screws.

High mechanical security of the fixings.

No functional impairment is caused by slight over tightening of the fixing screws.

Alternatively, Han coding elements (code pins or guide pins and bushes) may be used.

Please note: The strain relief element should be assembled to the latching part at the end of the insert opposite to the ground screw.

Up to 2 cable ties with max. 5 mm width can be used on the strain relief.

Label 9 x 20 mm may be fitted in both sides of each latching element.

Label 7 x 20 mm may be fitted to the top of the latching part without the strain relief element.
(more information page 11.19)

Technical characteristics





Min. retention force on counter part	without guiding system	with guiding system
	200 N	300 N
Vibration resistance	IEC 60 068, part 2-6 BN 74018	
Resistance to shock	IEC 60 068, part 2-27 BN 74018	
Torsional moment of fixing screws/ coding elements	0.8 Nm	
Material	Thermoplastic resin, polycarbonate, RAL 7032, grey	
Flammability acc. to UL 94	V 0	
Limiting temperatures	-40 °C ... +125 °C	
Degree of protection acc. to DIN EN 60 529 for coupled connector	IP 20	

Range of delivery

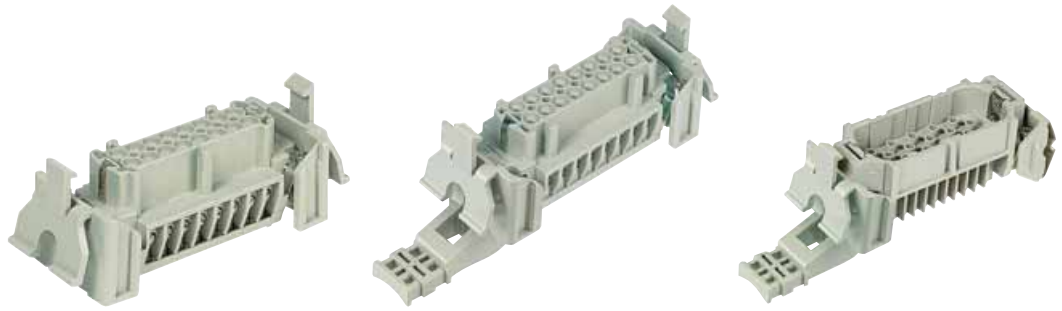
Delivery comprises:

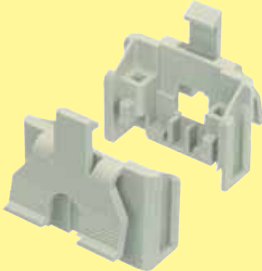
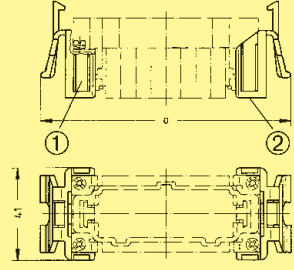
09 33 000 9987	2 latching parts
09 33 000 9991	1 latching part with strain relief 1 latching part
09 33 000 9990	1 latching part with strain relief 1 panel mounting part

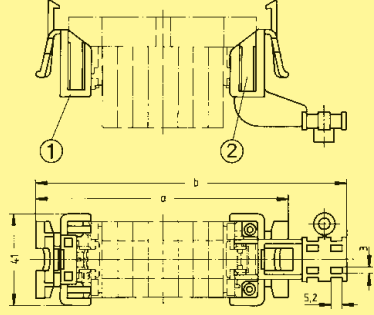

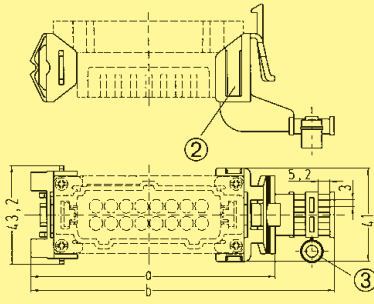
Identification	Part number	Drawing	Dimensions in mm															
<p>Latching parts</p> 	<p>09 33 000 9987</p>																	
<p>Latching parts with strain relief</p> 	<p>09 33 000 9991</p>	 <table border="1" data-bbox="925 1276 1268 1433"> <thead> <tr> <th>Size</th> <th>a</th> <th>b</th> </tr> </thead> <tbody> <tr> <td>6 B</td> <td>78.5</td> <td>105</td> </tr> <tr> <td>10 B</td> <td>91.5</td> <td>118</td> </tr> <tr> <td>16 B</td> <td>112</td> <td>138.5</td> </tr> <tr> <td>24 B</td> <td>138.5</td> <td>165</td> </tr> </tbody> </table>	Size	a	b	6 B	78.5	105	10 B	91.5	118	16 B	112	138.5	24 B	138.5	165	
Size	a	b																
6 B	78.5	105																
10 B	91.5	118																
16 B	112	138.5																
24 B	138.5	165																
<p>Latching parts with strain relief and Panel mounting parts</p> 	<p>09 33 000 9990</p>	 <table border="1" data-bbox="925 1780 1268 1937"> <thead> <tr> <th>Size</th> <th>a</th> <th>b</th> </tr> </thead> <tbody> <tr> <td>6 B</td> <td>75</td> <td>101</td> </tr> <tr> <td>10 B</td> <td>88</td> <td>114</td> </tr> <tr> <td>16 B</td> <td>108.5</td> <td>134.5</td> </tr> <tr> <td>24 B</td> <td>135</td> <td>161</td> </tr> </tbody> </table> <p>① Slot for identification strips 7 mm ② Slot for identification strips 9 mm ③ Distance bush</p>	Size	a	b	6 B	75	101	10 B	88	114	16 B	108.5	134.5	24 B	135	161	
Size	a	b																
6 B	75	101																
10 B	88	114																
16 B	108.5	134.5																
24 B	135	161																

Features

- Snap element for sheet-metal cut out
- practical and easy handling
- Reduction of material and assembly costs
- For all standard Han® B inserts and terminal block connectors
- Space saving

Connector inserts and terminal block connectors can be fixed on elements for panel mounting with standard insert mounting screws.

High mechanical security of the fixings. No functional impairment is caused by slight over tightening of the fixing screws.

Alternatively, Han coding elements (code pins or guide pins and bushes) may be used.

Connector assembly into the panel (sheet-metal) cut out or two parallel mounted rails is possible from mating or termination side.

Technical characteristics

Min. retention force in sheet-metal cut out	Mating		Unmating	
	without guiding system	with guiding system	without guiding system	with guiding system
	250 N	400 N	400 N	500 N
Vibration resistance	IEC 60 068, part 2-6 BN 74018			
Resistance to shock	IEC 60 068, part 2-27 BN 74018			
Torsional moment of fixing screws/ coding elements	0.8 Nm			
Material	Thermoplastic resin, polycarbonate, RAL 7032, grey			
Flammability acc. to UL 94	V 0			
Limiting temperatures	-40 °C ... +125 °C			

Range of delivery

Delivery comprises:

2 panel plastic mounting parts sufficient for one insert or terminal block connector



Identification

Part number

Drawing

Dimensions in mm

Panel mounting parts
Thermoplastic



09 33 000 9985

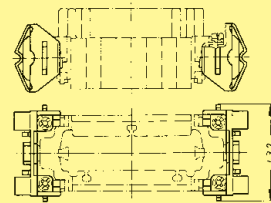

Panel cut out
Sheet-metal thickness 1.3 - 3 mm

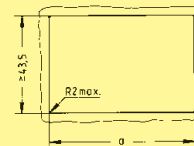

Size	a ^{+0.5}
6 B	65
10 B	78
16 B	98
24 B	125
10 A*	81.5
16 A*	98

* with corresponding adapter (see page 11.18-19)

Features

- Snap element for sheet-metal cut out
- practical and easy handling
- Reduction of material and assembly costs
- For all standard Han® B inserts and terminal block connectors
- Space saving

Connector inserts and terminal block connectors can be fixed on elements for panel mounting with standard insert mounting screws.

High mechanical security of the fixings.

Alternatively, Han coding elements (code pins or guide pins and bushes) may be used.

Connector assembly into the panel (sheet-metal) cut out or two parallel mounted rails is possible from mating or termination side.

Technical characteristics

Min. retention force in sheet-metal cut out	Mating		Unmating	
	without guiding system	with guiding system	without guiding system	with guiding system
	250 N	400 N	400 N	500 N
Vibration resistance	IEC 60 068, part 2-6 BN 74018			
Resistance to shock	IEC 60 068, part 2-27 BN 74018			
Torsional moment of fixing screws/ coding elements	0.8 Nm			
Material	zinc die-cast			
Limiting temperatures	-40 °C ... +125 °C			

Range of delivery

Delivery comprises:

2 panel metallic mounting parts sufficient for one insert or terminal block connector



Identification

Part number

Drawing

Dimensions in mm

Panel mounting parts

Metal

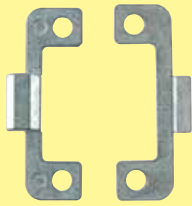

09 33 000 9984

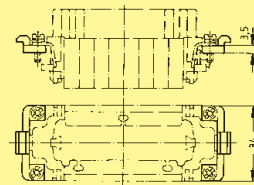

Panel cut out

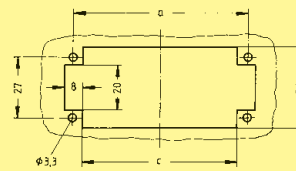

Size	a	c
6 B	44	36
10 B	57	49
16 B	77.5	69.5
24 B	104	96

Features

- Insert mounting with carrier element
- Suitable for all standard inserts size Han® 6 B / Han® 10 B / Han® 16 B / Han® 24 B
- A practical solution to fix the insert directly on a standard rail
- Insert can be assembled to Han-Snap® element with screwdriver
- Space saving

The carrier element is the basic element to mount the inserts in the cross direction on standard rails, for example:

- Caprail, 35 x 7.5 or 35 x 15 acc. to DIN EN 60 715
- C-rail, C 30 acc. to DIN EN 60 715
- G-rail, G 32 acc. to DIN EN 60 715

Where vibration is likely to be encountered, use the 35 x 15 mounting rails. When using the large carrier element, the 35 x 15 mounting rails are recommended to give greater stability.

Insert mounting type 6/10 is suitable for inserts of sizes Han 6 B and Han 10 B.

Insert mounting type 6/24 is suitable for all insert sizes: Han 6 B / 10 B / 16 B / 24 B, Han 16 A with the corresponding adapter.

Inserts can be assembled to the insert mountings with the standard insert mounting screws.

High mechanical security of the fixings. No functional impairment is caused by slight over tightening of the fixing screws.

Alternatively, Han coding elements (code pins or guide pins and bushes) may be used.

The following labels may be fitted to the insert mounting parts for circuit identification purposes:

- label 7 x 20 mm or
- label 9 x 20 mm (more information page 11.19)

Technical characteristics

Min. retention force on rail	450 N
Vibration resistance	IEC 60 068, part 2-6 BN 74018
Resistance to shock	IEC 60 068, part 2-27 BN 74018
Torsional moment of fixing screws/ coding elements	0.8 Nm
Material	polycarbonate
Flammability acc. to UL 94	V 0
Limiting temperatures	-40 °C ... +125 °C

Range of delivery

Delivery comprises:

- 2 insert mounting parts
- 1 carrier element

Features

- Insert mounting with carrier element
- Suitable for all standard inserts size Han® 6 B, Han® 10 B, Han® 16 B, Han® 24 B
- A practical solution to fix the insert directly on a standard rail
- Insert can be assembled to Han-Snap® element with screwdriver
- Space saving

The insert mounting locks directly on standard rail 35 x 15 or 35 x 7.5 mm.

Inserts can be assembled on the insert mounting with the standard insert fixing screws.

High mechanical security of the fixings.

No functional impairment is caused by slight over tightening of the fixing screws.

Alternatively, Han® coding elements (code pins or guide pins and bushes) may be used.

The following labels may be fitted alternatively to the insert mounting parts for circuit identification purposes:

label 7 x 20 mm or

label 9 x 20 mm (more information page 11.19)

Technical characteristics

Min. retention force on rail	Tension	Pressure
	300 N	1000 N
Torsional moment of fixing screws/ coding elements	0.8 Nm	
Material	Thermoplastic resin, polycarbonate, RAL 7032, grey	
Flammability acc. to UL 94	V 0	
Limiting temperatures	-40 °C ... +125 °C	

Range of delivery

Delivery comprises:

2 insert mounting parts

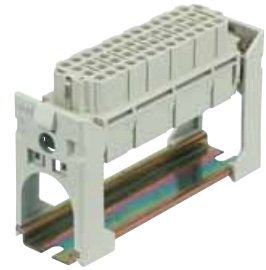

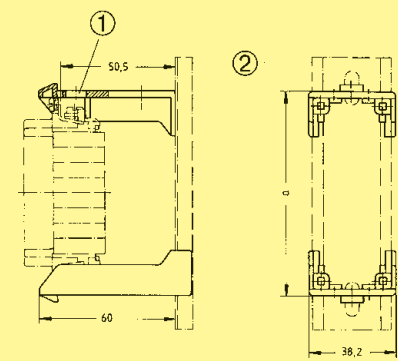
Identification	Part number	Drawing	Dimensions in mm														
<p>Insert mounting</p> 	<p>09 33 000 9980</p>	 <table border="1" data-bbox="981 974 1212 1198"> <thead> <tr> <th>Size</th> <th>a</th> </tr> </thead> <tbody> <tr> <td>6 B</td> <td>57</td> </tr> <tr> <td>10 B</td> <td>70</td> </tr> <tr> <td>16 B</td> <td>90.5</td> </tr> <tr> <td>24 B</td> <td>117</td> </tr> <tr> <td>10 A*</td> <td>74</td> </tr> <tr> <td>16 A*</td> <td>90.5</td> </tr> </tbody> </table> <p>① Slot for identification strip ② Rail DIN EN 60 715-35 x 7.5 or -35 x 15</p> <p>* with corresponding adapter (see page 11.18-19)</p>	Size	a	6 B	57	10 B	70	16 B	90.5	24 B	117	10 A*	74	16 A*	90.5	<p>Han Snap</p>
Size	a																
6 B	57																
10 B	70																
16 B	90.5																
24 B	117																
10 A*	74																
16 A*	90.5																

Features

- Ideal for use within closed electrical operation environments
- Allows use of preassembled cables
- Optimised cost of material and assembly
- Insert can be assembled to Han-Snap® element with screwdriver

2 identical half shells form a shell housing.

Each housing has 3 cable entries, one on top and one at each end. 2 x cable entries can be closed by enclosed blind plugs.

In the area of cable entries there are rectangular openings for mounting of cable ties up to max. 5 mm width.

In the mating area both housing shells are fixed by the standard insert fixing screws.

To release the half shells use screw driver (3.5 x 0.5).

Alternatively, Han® coding elements (code pins or guide pins and bushings) may be used.

High mechanical security of the fixings.

No functional impairment is caused by slight over tightening of the fixing screws. The blind plugs have slots for identification strips.

The following labels can be fitted:

label 7 x 20 mm or

label 9 x 20 mm (more information page 11.19)

Technical characteristics



Min. retention force, fixed	300 N
Vibration resistance	IEC 60 068, part 2-6 BN 74018
Resistance to shock	IEC 60 068, part 2-27 BN 74018
Torsional moment of fixing screws/ coding elements	0.8 Nm
Material	Thermoplastic resin, polycarbonate, RAL 7032, grey
Flammability acc. to UL 94	V 0
Limiting temperatures	-40 °C ... +125 °C

Range of delivery

Delivery comprises:

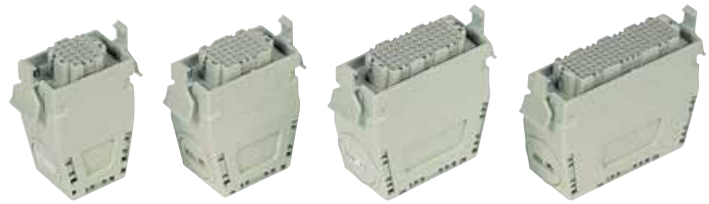
2 half shells with blind plugs

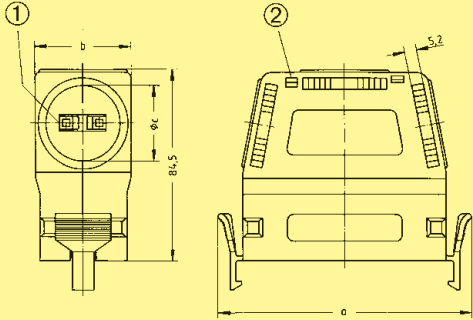

Identification	Size	Part number	Drawing	Dimensions in mm																				
Plastic housings 	6 B	09 33 006 0401	 <table border="1" data-bbox="919 949 1377 1108"> <thead> <tr> <th>Size</th> <th>a</th> <th>b</th> <th>c</th> </tr> </thead> <tbody> <tr> <td>6 B</td> <td>78.5</td> <td>39</td> <td>24</td> </tr> <tr> <td>10 B</td> <td>91.5</td> <td>43</td> <td>30</td> </tr> <tr> <td>16 B</td> <td>112</td> <td>43</td> <td>34</td> </tr> <tr> <td>24 B</td> <td>138.5</td> <td>43</td> <td>34</td> </tr> </tbody> </table> <p>① Blind plug with slot for identification strips ② Opening for release</p> <p>* Han A-size 16 by using the corresponding adapter (see page 11.18-19)</p>	Size	a	b	c	6 B	78.5	39	24	10 B	91.5	43	30	16 B	112	43	34	24 B	138.5	43	34	
	Size	a		b	c																			
	6 B	78.5		39	24																			
	10 B	91.5		43	30																			
	16 B	112		43	34																			
24 B	138.5	43	34																					
10 B	09 33 010 0401																							
16 B*	09 33 016 0401																							
24 B	09 33 024 0401																							
Protection covers	6 B	09 33 006 5401	 <table border="1" data-bbox="1034 1435 1265 1594"> <thead> <tr> <th>Size</th> <th>a</th> </tr> </thead> <tbody> <tr> <td>6 B</td> <td>81.5</td> </tr> <tr> <td>10 B</td> <td>94.5</td> </tr> <tr> <td>16 B</td> <td>115</td> </tr> <tr> <td>24 B</td> <td>141.5</td> </tr> </tbody> </table>	Size	a	6 B	81.5	10 B	94.5	16 B	115	24 B	141.5											
	Size	a																						
	6 B	81.5																						
	10 B	94.5																						
	16 B	115																						
24 B	141.5																							
10 B	09 33 010 5401																							
16 B	09 33 016 5401																							
24 B	09 33 024 5401																							

Features

- Accessories compatible for all contact inserts series Han A®, 10 and 16 pins; series Han D®, 15 and 25 pins
- Practical and easy handling
- Reduction of material and assembly costs
- Compatible with Han-Snap® elements: Panel mounting parts, Latching parts, Insert mountings, Plastic hood size 16 for Han 25 D® and Han A® 16 poles

Inserts can be assembled to the adapters with the standard insert fixing screws.

With the included screws the adapter can be fixed to the selected Han-Snap® element.

Technical characteristics

Torsional moment of fixing screws/coding elements	0.8 Nm
Material	Thermoplastic resin, polycarbonate, RAL 7032, grey
Flammability acc. to UL 94	V 0
Limiting temperatures	-40 °C ... +125 °C

Range of delivery

Delivery comprises:

- 2 adapters
- 4 fixing screws

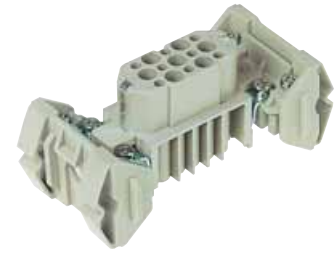

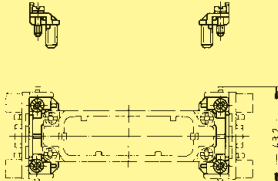
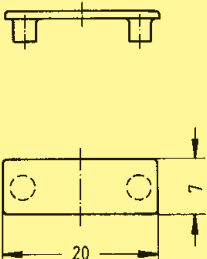
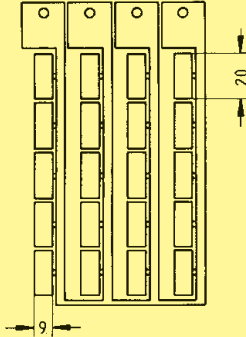
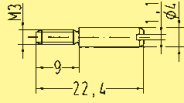
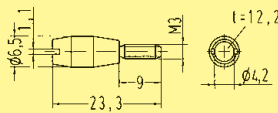
Identification	Part number	Drawing	Dimensions in mm
<p>Adapter Han A®</p> 	<p>09 20 000 9933</p>		
<p>Identification strips single 7 mm wide / 20 mm long</p>	<p>09 33 000 9981</p>		<p>Han Snap</p>
<p>Identification strips 20 pieces in one block 9 mm width / 20 mm length</p>	<p>09 33 000 9982</p>		
<p>Guide pin</p>	<p>09 33 000 9956</p>		
<p>Guide bushing</p>	<p>09 33 000 9957</p>		

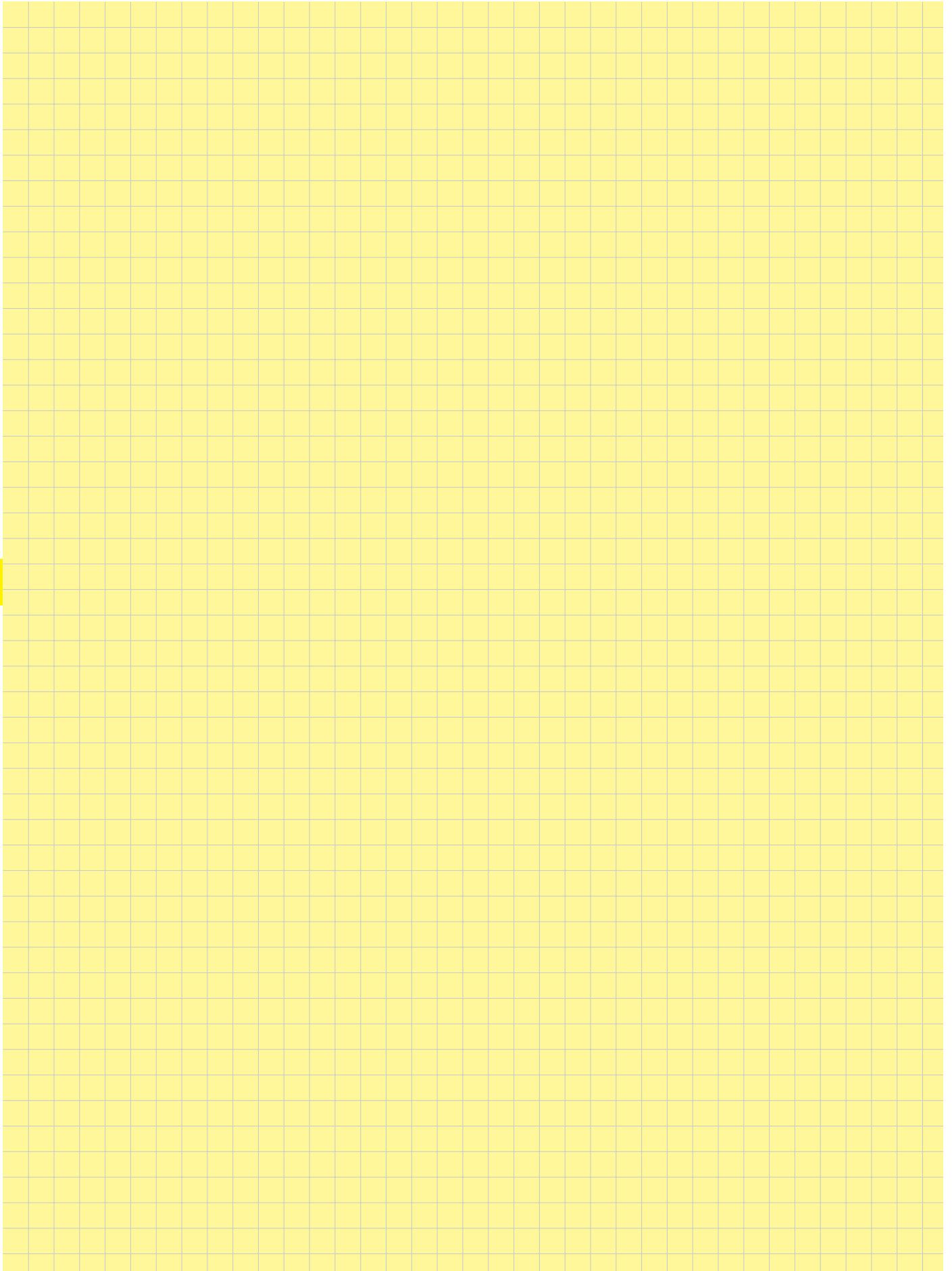

Han
Snap