

## Contents

|   | Page         |
|---|--------------|
| Technical characteristics Han DD® with PCB adapter .....      | <b>20.02</b> |
| Han DD® with PCB adapter .....                                | <b>20.03</b> |
| Technical characteristics Han E® with PCB adapter .....       | <b>20.04</b> |
| Han E® with PCB adapter .....                                 | <b>20.05</b> |
| Technical characteristics Han® Q 4/2 with PCB adapter .....   | <b>20.06</b> |
| Han® Q 4/2 with PCB adapter .....                             | <b>20.07</b> |
| Technical characteristics Han® Q 5/0 with PCB adapter .....   | <b>20.08</b> |
| Han® Q 5/0 with PCB adapter .....                             | <b>20.09</b> |
| Technical characteristics Han® Q 7/0 with PCB adapter .....   | <b>20.10</b> |
| Han® Q 7/0 with PCB adapter .....                             | <b>20.11</b> |
| Technical characteristics Han® Q 8/0 with PCB adapter .....   | <b>20.12</b> |
| Han® Q 8/0 with PCB adapter .....                             | <b>20.13</b> |
| Technical characteristics Han-Modular® with PCB adapter ..... | <b>20.14</b> |
| Han-Modular® with PCB adapter .....                           | <b>20.15</b> |
| Applications .....  | <b>20.16</b> |

## Features

- ❑ Robust design
- ❑ Suitable for standard and EMC housing
- ❑ Low wiring costs
- ❑ Higher contact density

## Technical characteristics

### Approvals



### Inserts

Number of contacts 24, 42, 72, 108

Electrical data  
acc. to DIN EN 61984

**7.5 A 250 V 4 kV 3**

Working current  
Working voltage  
Rated impulse voltage  
Pollution degree

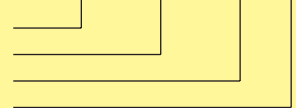

Working voltage  
acc. to UL

250 V

Testing voltage  $U_{rms}$   
Insulation resistance

2 kV  
 $\geq 10^{10} \Omega$

Material

Polyamide

Limiting temperatures

- 40 °C / +125 °C

Flammability acc. to UL 94

HB

Mechanical working life

$\geq 500$

- Mating cycles

Wire gauge

0.14 - 2.5 mm<sup>2</sup>

## Layout of printed circuit boards

Han<sup>®</sup> 24 DD

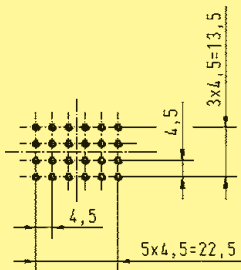

Han<sup>®</sup> 42 DD

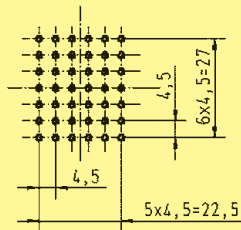

Han<sup>®</sup> 72 DD

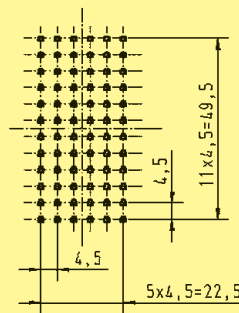

Han<sup>®</sup> 108 DD

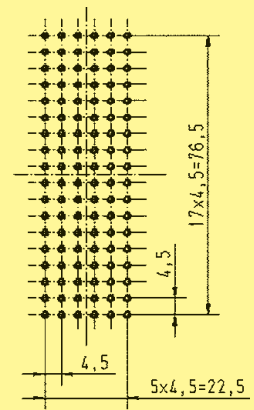

Recommended hole diameter: 0.8 mm

## Assembly situation

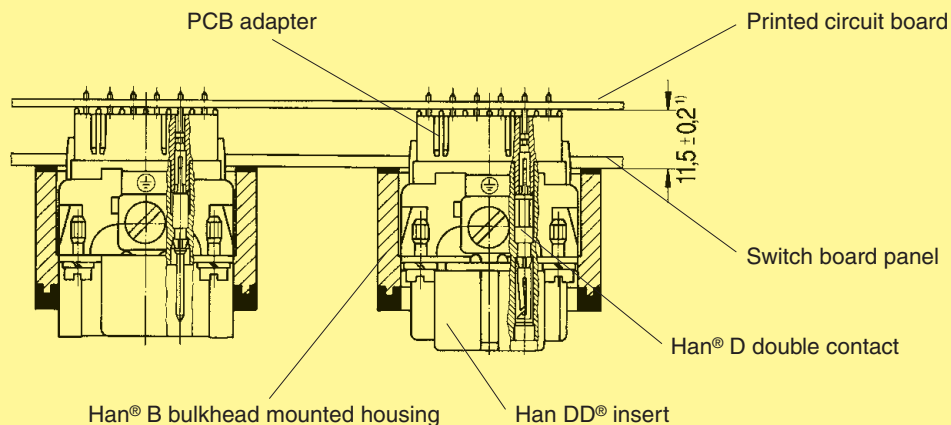

<sup>1)</sup> for Han<sup>®</sup> B EMC hoods/housings spacing of  $12.5 \pm 0.2$  is necessary as no flange seal is used.



| Insert  | Size   | Part No.   |                       | Drawing   | Dimensions in mm  |      |   |                |               |                |     |       |         |      |       |      |         |        |     |     |         |      |     |     |          |
|---|--|--|-----------------------|---|---|------|---|----------------|---------------|----------------|-----|-------|---------|------|-------|------|---------|--------|-----|-----|---------|------|-----|-----|----------|
|   |  | Male insert (M)  | Female insert (F)     |   |   |      |   |                |               |                |     |       |         |      |       |      |         |        |     |     |         |      |     |     |          |
| Order contacts separately   |  |  |                       |   |   |      |   |                |               |                |     |       |         |      |       |      |         |        |     |     |         |      |     |     |          |
| Han <sup>®</sup> 24 DD  | 6 B  | <b>09 16 024 3001</b>  | <b>09 16 024 3101</b> |   | 1) Distance for contact max. 21 mm<br><table border="1"> <thead> <tr> <th></th> <th>a</th> <th>b</th> </tr> </thead> <tbody> <tr> <td>24 DD</td> <td>44</td> <td>51</td> </tr> <tr> <td>42 DD</td> <td>57</td> <td>64</td> </tr> <tr> <td>72 DD</td> <td>77.5</td> <td>84.5</td> </tr> <tr> <td>108 DD</td> <td>104</td> <td>111</td> </tr> </tbody> </table> |      | a | b              | 24 DD         | 44             | 51  | 42 DD | 57      | 64   | 72 DD | 77.5 | 84.5    | 108 DD | 104 | 111 |         |      |     |     |          |
|   | a  | b  |                       |   |   |      |   |                |               |                |     |       |         |      |       |      |         |        |     |     |         |      |     |     |          |
| 24 DD   | 44   | 51   |                       |   |   |      |   |                |               |                |     |       |         |      |       |      |         |        |     |     |         |      |     |     |          |
| 42 DD   | 57   | 64   |                       |   |   |      |   |                |               |                |     |       |         |      |       |      |         |        |     |     |         |      |     |     |          |
| 72 DD   | 77.5   | 84.5   |                       |   |   |      |   |                |               |                |     |       |         |      |       |      |         |        |     |     |         |      |     |     |          |
| 108 DD  | 104  | 111  |                       |   |   |      |   |                |               |                |     |       |         |      |       |      |         |        |     |     |         |      |     |     |          |
| Han <sup>®</sup> 42 DD  | 10 B   | <b>09 16 042 3001</b>  | <b>09 16 042 3101</b> |   |   |      |   |                |               |                |     |       |         |      |       |      |         |        |     |     |         |      |     |     |          |
| Han <sup>®</sup> 72 DD  | 16 B   | <b>09 16 072 3001</b>  | <b>09 16 072 3101</b> |   |   |      |   |                |               |                |     |       |         |      |       |      |         |        |     |     |         |      |     |     |          |
| Han <sup>®</sup> 108 DD   | 24 B   | <b>09 16 108 3001</b>  | <b>09 16 108 3101</b> |   |   |      |   |                |               |                |     |       |         |      |       |      |         |        |     |     |         |      |     |     |          |
| Han D <sup>®</sup> double contacts  |  | Part No.   |                       | Drawing   | Dimensions in mm  |      |   |                |               |                |     |       |         |      |       |      |         |        |     |     |         |      |     |     |          |
| to connect the PCB adapter  |  | Male contacts  | Female contacts       |   |   |      |   |                |               |                |     |       |         |      |       |      |         |        |     |     |         |      |     |     |          |
|   |  | <b>09 15 000 6191</b>  | <b>09 15 000 6291</b> |   |   |      |   |                |               |                |     |       |         |      |       |      |         |        |     |     |         |      |     |     |          |
| PCB adapter   | Part No.                                       |  | Drawing               | Dimensions in mm  |   |      |   |                |               |                |     |       |         |      |       |      |         |        |     |     |         |      |     |     |          |
|   | for PCBs up to 1.6 mm<br>for PCBs up to 2.4 mm |  |                       |   |   |      |   |                |               |                |     |       |         |      |       |      |         |        |     |     |         |      |     |     |          |
|   |  | <b>09 16 000 9905</b><br><b>09 16 000 9908</b>   |                       | <table border="1"> <thead> <tr> <th></th> <th>a</th> </tr> </thead> <tbody> <tr> <td>09 16 000 9905</td> <td>2.6</td> </tr> <tr> <td>09 16 000 9908</td> <td>3.4</td> </tr> </tbody> </table>   |   |      | a | 09 16 000 9905 | 2.6           | 09 16 000 9908 | 3.4 |       |         |      |       |      |         |        |     |     |         |      |     |     |          |
|   | a  |  |                       |   |   |      |   |                |               |                |     |       |         |      |       |      |         |        |     |     |         |      |     |     |          |
| 09 16 000 9905  | 2.6  |  |                       |   |   |      |   |                |               |                |     |       |         |      |       |      |         |        |     |     |         |      |     |     |          |
| 09 16 000 9908  | 3.4  |  |                       |   |   |      |   |                |               |                |     |       |         |      |       |      |         |        |     |     |         |      |     |     |          |
| Housing   | Size   | Part No.   | Drawing               | Dimensions in mm  |   |      |   |                |               |                |     |       |         |      |       |      |         |        |     |     |         |      |     |     |          |
|   | 6 B<br>10 B<br>16 B<br>24 B                    | <b>09 30 006 0301</b><br><b>09 30 010 0301</b><br><b>09 30 016 0301</b><br><b>09 30 024 0301</b> |                       | <table border="1"> <thead> <tr> <th>Size</th> <th>a</th> <th>b</th> <th>Panel cut out</th> </tr> </thead> <tbody> <tr> <td>6 B</td> <td>70</td> <td>80</td> <td>48 x 35</td> </tr> <tr> <td>10 B</td> <td>83</td> <td>93</td> <td>60 x 35</td> </tr> <tr> <td>16 B</td> <td>103</td> <td>113</td> <td>82 x 35</td> </tr> <tr> <td>24 B</td> <td>130</td> <td>140</td> <td>108 x 35</td> </tr> </tbody> </table> Size 6 B with 1 locking lever |   | Size | a | b              | Panel cut out | 6 B            | 70  | 80    | 48 x 35 | 10 B | 83    | 93   | 60 x 35 | 16 B   | 103 | 113 | 82 x 35 | 24 B | 130 | 140 | 108 x 35 |
| Size  | a  | b  | Panel cut out         |   |   |      |   |                |               |                |     |       |         |      |       |      |         |        |     |     |         |      |     |     |          |
| 6 B   | 70   | 80   | 48 x 35               |   |   |      |   |                |               |                |     |       |         |      |       |      |         |        |     |     |         |      |     |     |          |
| 10 B  | 83   | 93   | 60 x 35               |   |   |      |   |                |               |                |     |       |         |      |       |      |         |        |     |     |         |      |     |     |          |
| 16 B  | 103  | 113  | 82 x 35               |   |   |      |   |                |               |                |     |       |         |      |       |      |         |        |     |     |         |      |     |     |          |
| 24 B  | 130  | 140  | 108 x 35              |   |   |      |   |                |               |                |     |       |         |      |       |      |         |        |     |     |         |      |     |     |          |
| Further informations see chapter 02 (Han D <sup>®</sup> / DD <sup>®</sup> ) |  |  |                       |   |   |      |   |                |               |                |     |       |         |      |       |      |         |        |     |     |         |      |     |     |          |

PCB-Adapter

## Features

- ❑ Robust design
- ❑ Suitable for standard and EMC housings
- ❑ Low wiring costs
- ❑ Counter connector available with screw, crimp or cage clamp termination

## Technical characteristics

### Inserts

Number of contacts 6, 10, 16, 24

Electrical data  
acc. to DIN EN 61 984

Working current  
Working voltage  
Rated impulse voltage  
Pollution degree

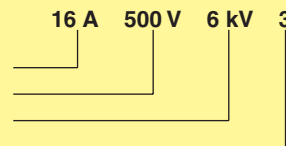

Insulation resistance  
Material  
Limiting temperatures  
Flammability acc. to UL 94  
Mechanical working life  
- Mating cycles  
Wire gauge

$\geq 10^{10} \Omega$   
Polycarbonate  
- 40 °C / +125 °C  
V 0  
 $\geq 500$   
0.5 - 4 mm<sup>2</sup>

## Layout of printed circuit boards

Han<sup>®</sup> 6 E

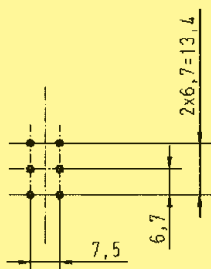

Han<sup>®</sup> 10 E

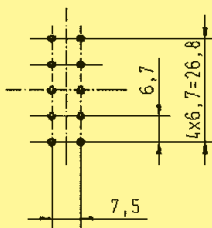

Han<sup>®</sup> 16 E

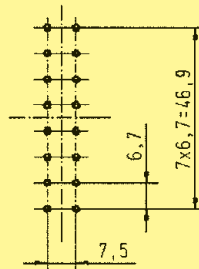

Han<sup>®</sup> 24 E

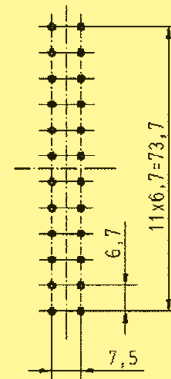

Recommended hole diameter: 1.8 mm

## Assembly situation

PCB  
adapter

Printed  
circuit board

Han<sup>®</sup> B housing  
bulkhead mounting

Switch cabinet  
panel

Han E<sup>®</sup> Insert

Han E<sup>®</sup> double contact

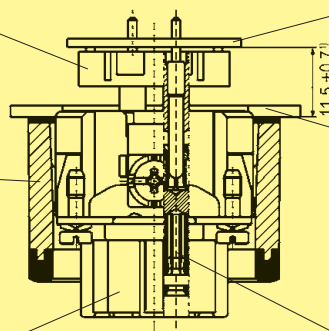

<sup>1)</sup> for Han<sup>®</sup> B EMC hoods/housings spacing of  $12.5 \pm 0.7$  is necessary as no flange seal is used



## Features

- ❑ Robust Design
- ❑ Suitable for Han-Compact® hoods and housings
- ❑ Low wiring costs
- ❑ High contact density

## Technical characteristics

|  |                              |
|--|------------------------------|
| Approvals                                |                              |
| Number of contacts                       | 4/2 + PE                     |
| Electrical data acc. to<br>DIN EN 61 984 |                              |
| Power area                               | <b>30 A 400/690 V 6 kV 2</b> |
| Rated current                            | 30 A                         |
| Rated voltage                            |                              |
| conductor - ground                       | 400 V                        |
| conductor - conductor                    | 690 V                        |
| Rated impulse voltage                    | 6 kV                         |
| Pollution degree                         | 2                            |
| Signal area                              | <b>7.5 A 250 V 4 kV 2</b>    |
| Rated current                            | 7.5 A                        |
| Rated voltage                            | 250 V                        |
| Rated impulse voltage                    | 4 kV                         |
| Pollution degree                         | 2                            |
| Insulation resistance                    | ≥ 10 <sup>10</sup> Ω         |
| Material – PCB adapter                   | LCP                          |
| Limiting temperatures                    | -40 °C ... +125 °C           |
| Flammability acc. to UL 94               | V 0                          |
| Mechanical working life                  | ≥ 500 mating cycles          |



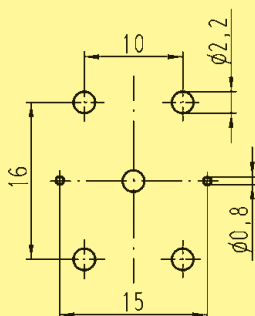

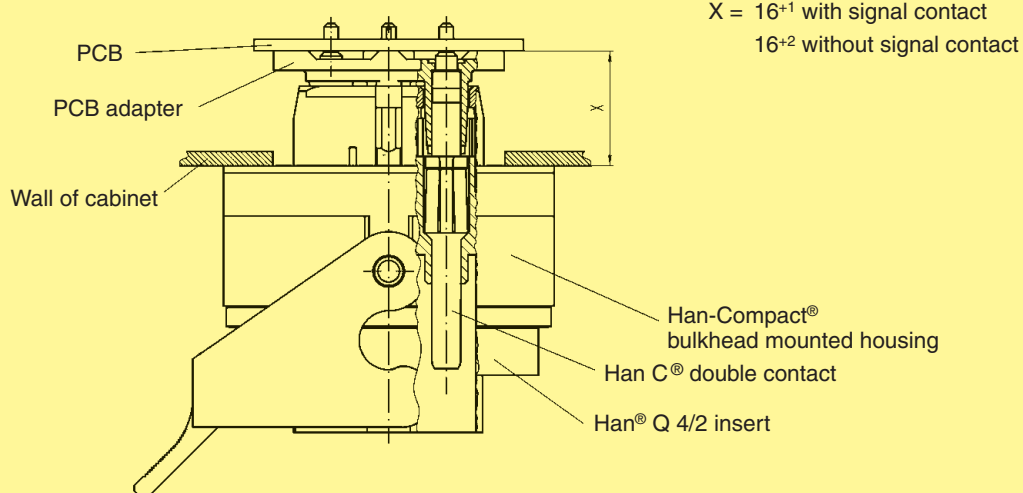

## Layout of printed circuit boards

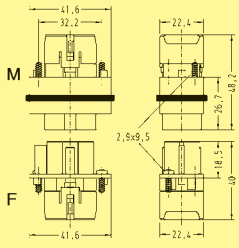

## Assembly situation

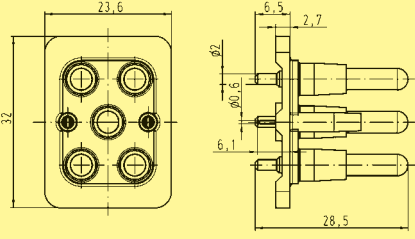

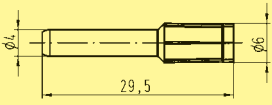
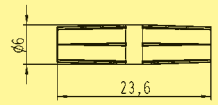
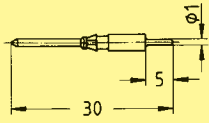
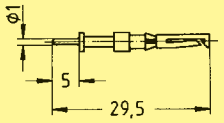

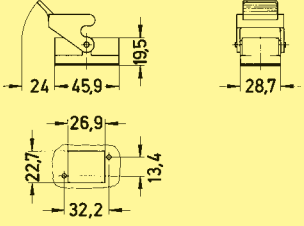
| Insert  | Part No.                              |   | Drawing  | Dimensions in mm  |
|---|---------------------------------------|---|--|---|
|   | Male insert (M)                       | Female insert (F)                       |  |   |
| Order contacts separately<br>  | <b>09 12 006 3041</b>                 | <b>09 12 006 3141</b>                   |                      | <b>Contact arrangement</b><br>View from termination side<br> |
| <b>PCB adapter</b><br>for PCBs up to 2.4 mm<br>  | <b>09 12 006 9901</b>                 |   |                    |   |
| <b>Double contacts</b><br>to connect the PCB adapter<br>Han C® double contacts<br>Power contact<br><br>Han D® double contacts<br>Signal contact<br> | Male contact<br><b>09 32 000 6180</b> | Female contact<br><b>09 32 000 6280</b> |                    |    |
|   | Male contact<br><b>09 15 000 6191</b> | Female contact<br><b>09 15 000 6293</b> |                    |    |
| <b>Housing Han-Compact®</b><br>Housing bulkhead mounting<br>Plastic<br>  | <b>09 12 008 0327</b>                 |   | Panel cut out<br> |   |
| Further informations<br>see chapter 13 (Han® Q)   |                                       |   |  |   |

Device side

Cable side

PCB-Adapter

## Features

- ❑ Robust design
- ❑ Suitable for EMC housings
- ❑ Low wiring costs
- ❑ Additional robust and secure PE-connection between housing and PCB

## Technical characteristics

### Approvals



### Inserts

Number of contacts 5

Electrical data acc. to DIN EN 61 984

10 A 230/400 V 4 kV 3

Working current  
Working voltage conductor – ground  
Working voltage conductor – conductor  
Rated impulse voltage  
Pollution degree

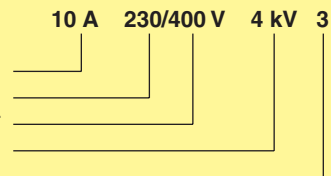

- pollution degree 2 also 10 A 320/500 V 4 kV 2

Working voltage acc. to UL/CSA 400 V

Insulation resistance  $\geq 10^{10} \Omega$   
Material Polycarbonate  
Limiting temperatures - 40 °C ... +125 °C  
Flammability acc. to UL 94 V 0  
Mechanical working life - Mating cycles  $\geq 500$

## Layout of printed circuit boards

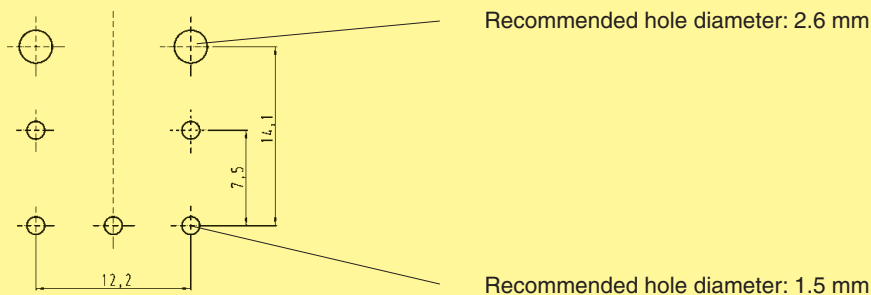

## Assembly situation

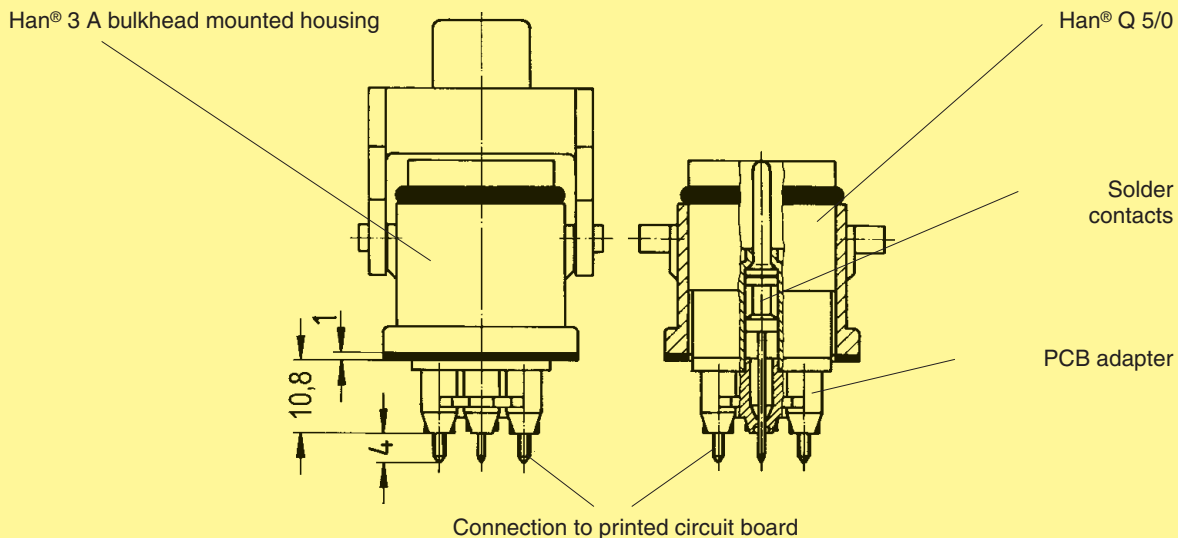



| Device side | Insert                                       |                   | Part No.              | Drawing               | Dimensions in mm |
|-------------|--|-------------------|-----------------------|-----------------------|------------------|
|             | Male insert (M)                              | Female insert (F) |                       |                       |                  |
|             | Order contacts separately                    |                   | <b>09 12 005 3001</b> | <b>09 12 005 3101</b> |                  |
|             | PCB adapter                                  |                   | Part No.              | Drawing               | Dimensions in mm |
|             | with PE contact panel                        |                   | <b>09 12 000 9905</b> |                       |                  |
|             | Solder contacts                              |                   | Part No.              | Drawing               | Dimensions in mm |
|             | to connect the PCB adapter                   |                   | <b>09 33 000 6195</b> | <b>09 33 000 6295</b> |                  |
|             | Housing bulkead mounting                     |                   | Part No.              | Drawing               | Dimensions in mm |
|             |  |                   | <b>09 62 003 0304</b> |                       |                  |
| Cable side  | Further informations see chapter 13 (Han® Q) |                   |                       |                       |                  |

PCB-Adapter

## Features

- ❑ Robust design
- ❑ Suitable for standard and EMC housings
- ❑ Low cost wiring
- ❑ High contact density

## Technical characteristics

### Approvals



### Inserts

Number of contacts 7

Electrical data  
acc. to DIN EN 61 984

7.5 A 250 V 4 kV 3

Working current  
Working voltage  
Rated impulse voltage  
Pollution degree

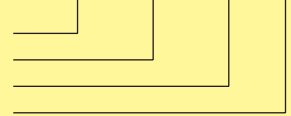

Insulation resistance  $\geq 10^{10} \Omega$   
Material Polycarbonate  
Limiting temperatures  $-40 \text{ }^\circ\text{C} \dots +125 \text{ }^\circ\text{C}$   
Flammability acc. to UL 94 V 0  
Mechanical working life  
- Mating cycles  $\geq 500$

## Layout of printed circuit boards

Recommended hole diameter: 0.8 mm



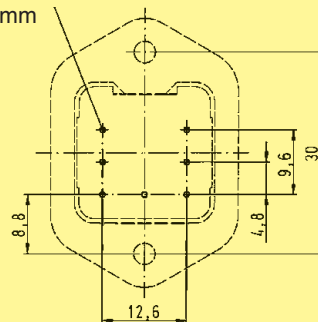

Dimensions in mm

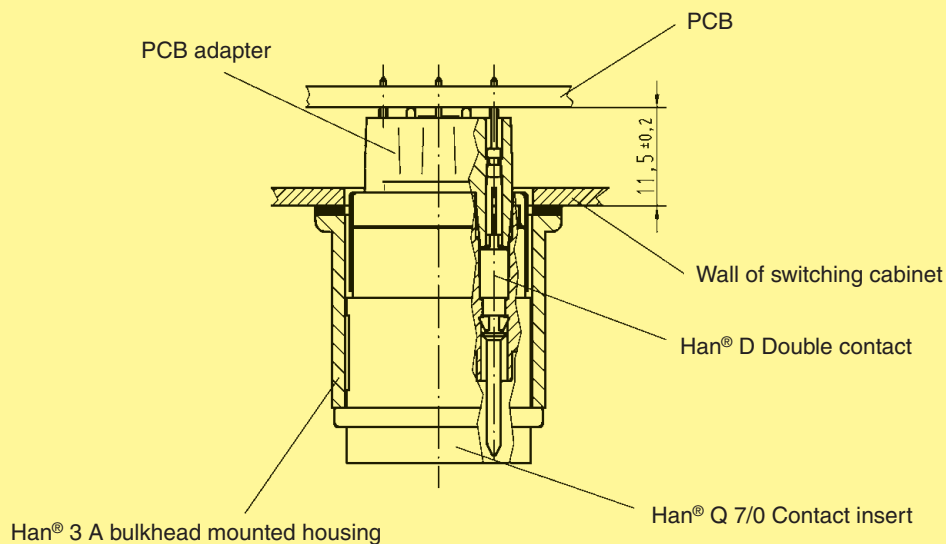

## Assembly situation

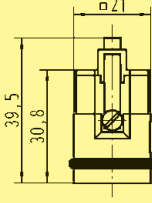
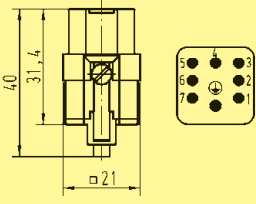
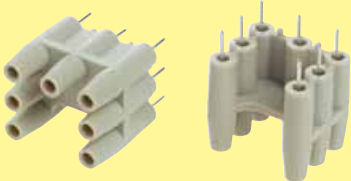
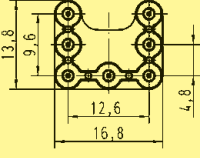
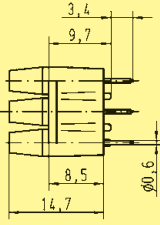

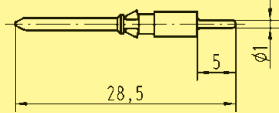
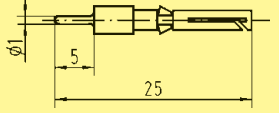

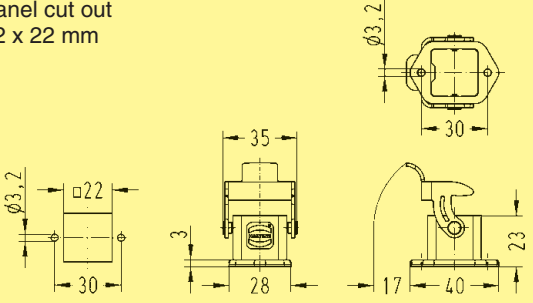
| Insert   | Part No.              |                       | Drawing   | Dimensions in mm |
|--|-----------------------|-----------------------|---|------------------|
|  | Male insert (M)       | Female insert (F)     |   |                  |
| Order contacts separately<br><br>Coding | <b>09 12 007 3001</b> | <b>09 12 007 3101</b> |      |                  |
| <b>09 12 000 9901</b>  | <b>09 12 000 9902</b> |                       |   |                  |
| PCB adapter  | Part No.              |                       | Drawing   | Dimensions in mm |
| for PCB up to 2.4 mm   |                       |                       |   |                  |
|                                        | <b>09 12 000 9908</b> |                       |   |                  |
|  |                       |                       |   |                  |
| Han D® double contacts   | Part No.              |                       | Drawing   | Dimensions in mm |
| to connect the PCB adapter   | Male contact          | Female contact        |   |                  |
|                                       | <b>09 15 000 6190</b> | <b>09 15 000 6290</b> |   |                  |
|  |                       |                       |   |                  |
| Housing bulkead mounting   | Part No.              |                       | Drawing   | Dimensions in mm |
|  |                       |                       |   |                  |
|                                       | <b>09 20 003 0301</b> |                       | Panel cut out<br>22 x 22 mm<br>   |                  |
|  |                       |                       |   |                  |
| Further informations see chapter 13 (Han® Q)   |                       |                       |   |                  |

PCB-Adapter

## Features

- ❑ Robust Design
- ❑ Suitable for Han-Compact® hoods and housings
- ❑ Low wiring costs
- ❑ High contact density

## Technical characteristics

|  |                              |
|--|------------------------------|
| Approvals                                |                              |
| Number of contacts                       | 8                            |
| Electrical data acc. to<br>DIN EN 61 984 | <b>16 A 230/400 V 4 kV 2</b> |
| Rated current                            | 16 A                         |
| Rated voltage                            |                              |
| conductor - ground                       | 230 V                        |
| conductor - conductor                    | 400 V                        |
| Rated impulse voltage                    | 4 kV                         |
| Pollution degree                         | 2                            |
| Insulation resistance                    | ≥ 10 <sup>10</sup> Ω         |
| Material – PCB adapter                   | LCP                          |
| Limiting temperatures                    | -40 °C ... +125 °C           |
| Flammability acc. to UL 94               | V 0                          |
| Mechanical working life                  | ≥ 500 mating cycles          |

## Layout of printed circuit boards

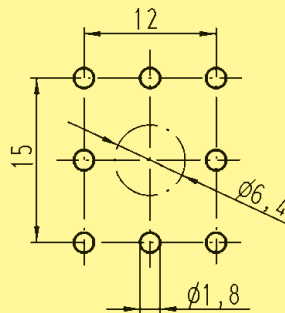

## Assembly situation

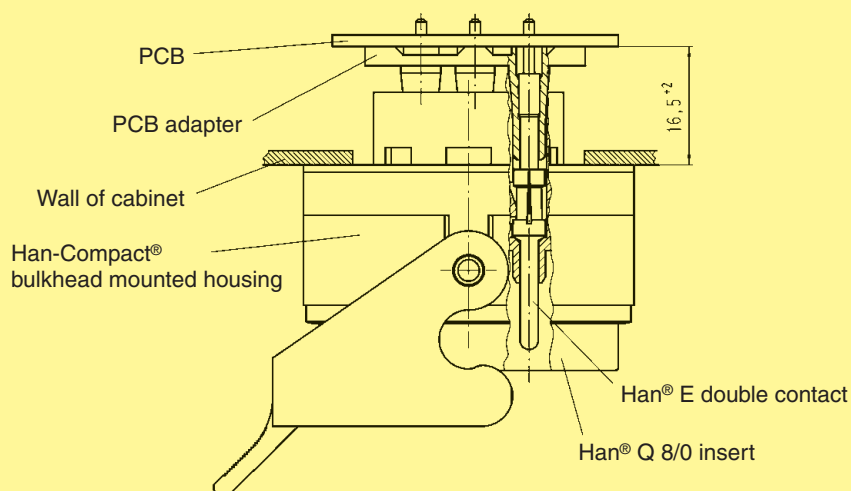



| Device side                                       | Insert                                       |                       | Part No.              |                   | Drawing  | Dimensions in mm |
|---|--|-----------------------|-----------------------|-------------------|--|------------------|
|   | Male insert (M)                              | Female insert (F)     |                       |                   |  |                  |
| Order contacts separately                         |  | <b>09 12 008 3001</b> | <b>09 12 008 3101</b> |                   | <b>Contact arrangement</b><br>View from termination side<br> |                  |
| PCB adapter for PCBs up to 1.6 mm                 |  |                       | <b>09 12 008 9901</b> |                   |  |                  |
| Han® E double contacts to connect the PCB adapter |  | <b>09 33 000 6180</b> | <b>09 33 000 6280</b> |                   |  |                  |
| Housing bulkead mounting Plastic                  |  |                       | <b>09 12 008 0327</b> | Panel cut out<br> |  |                  |
| Cable side  | Further informations see chapter 13 (Han® Q) |                       |                       |                   |  |                  |

PCB-Adapter

## Features

- ❑ Modular assembly
- ❑ Robust design
- ❑ Suitable for standard and EMC housings
- ❑ Low wiring costs

## Technical characteristics

### Han DD® module with PCB adapter

|                    |                            |
|--------------------|----------------------------|
| Number of contacts | 12                         |
| Working current    | 7.5 A                      |
| Working voltage    | 250 V                      |
| Wire gauge         | 0.14 - 2.5 mm <sup>2</sup> |

### Han® 40 A module for PCB adaptations

|                    |                          |
|--------------------|--------------------------|
| Number of contacts | 2                        |
| Working current    | 40 A                     |
| Working voltage    | 500 V                    |
| Wire gauge         | 2.5 - 10 mm <sup>2</sup> |

## Layout of printed circuit boards

Depiction

Recommended hole diameter: 0,8 mm

Recommended hole diameter: 3,2 mm

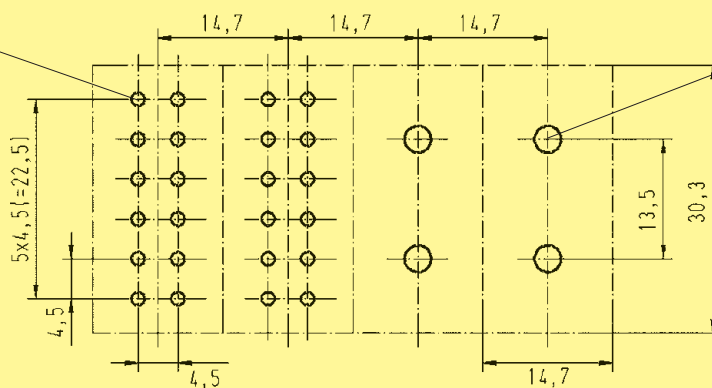

Han DD® module

Han® 40 A module

## Assembly situation

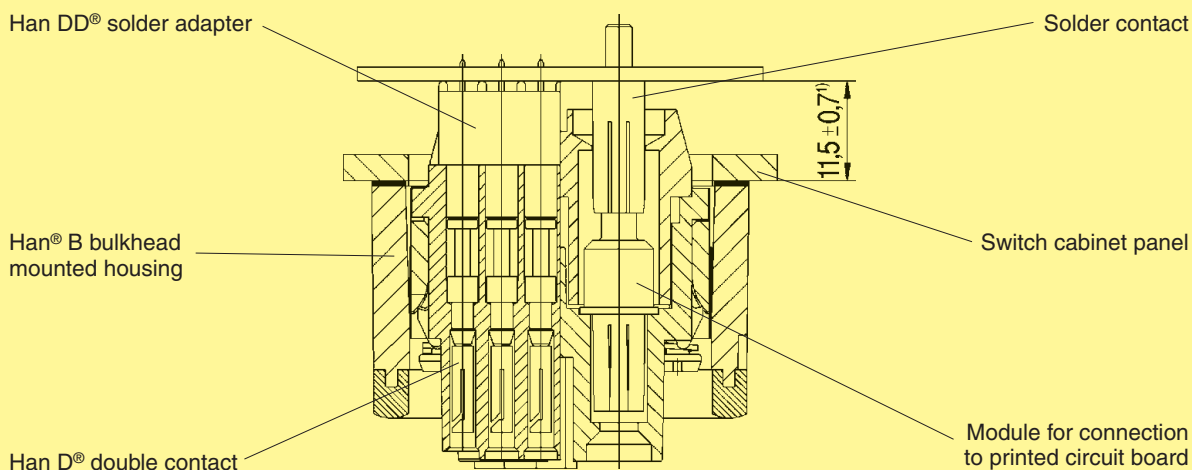

Han DD® solder adapter

Solder contact

Han® B bulkhead mounted housing

Switch cabinet panel

Han D® double contact

Module for connection to printed circuit board

<sup>1)</sup> for Han® B EMC hoods/housings spacing of 12.5 ± 0.7 is necessary as no flange seal is used

| Hinged frame | No. of modules | Part No.              |                       | Size | Figure   |
|--------------|----------------|-----------------------|-----------------------|------|--|
|              |                | Male insert (M)       | Female insert (F)     |      |  |
|              | 1              | <b>09 14 000 0304</b> | <b>09 14 000 0304</b> | 10 A | Drawings and further details see chapter 06 (Han-Modular®) |
|              | 2              | <b>09 14 006 0303</b> | <b>09 14 006 0313</b> | 6 B  |  |
|              | 3              | <b>09 14 010 0303</b> | <b>09 14 010 0313</b> | 10 B |  |
|              | 4              | <b>09 14 016 0303</b> | <b>09 14 016 0313</b> | 16 B |  |
|              | 4              | <b>09 14 016 0303</b> | <b>09 14 016 0313</b> | 16 B |  |
|              | 6              | <b>09 14 024 0303</b> | <b>09 14 024 0313</b> | 24 B |  |

| Identification   | Part No.                                       |                       | Drawing   | Dimensions in mm |   |                       |     |                       |     |  |
|--|--|-----------------------|---|------------------|---|-----------------------|-----|-----------------------|-----|--|
|  | Male insert (M)                                | Female insert (F)     |   |                  |   |                       |     |                       |     |  |
| <b>Han DD® module</b><br>PCB termination/<br>crimp termination<br>       | <b>09 14 012 3001</b>                          | <b>09 14 012 3101</b> |   |                  |   |                       |     |                       |     |  |
| <b>Han D® double contacts</b><br>to connect the PCB<br>                  | <b>09 15 000 6191</b>                          | <b>09 15 000 6291</b> |   |                  |   |                       |     |                       |     |  |
| <b>PCB adapter</b><br>for PCBs up to 1.6 mm<br>for PCBs up to 2.4 mm<br> | <b>09 16 000 9905</b><br><b>09 16 000 9908</b> |                       | <table border="1"> <tr> <td></td> <td>a</td> </tr> <tr> <td><b>09 16 000 9905</b></td> <td>2.6</td> </tr> <tr> <td><b>09 16 000 9908</b></td> <td>3.4</td> </tr> </table> |                  | a | <b>09 16 000 9905</b> | 2.6 | <b>09 16 000 9908</b> | 3.4 |  |
|  | a  |                       |   |                  |   |                       |     |                       |     |  |
| <b>09 16 000 9905</b>  | 2.6  |                       |   |                  |   |                       |     |                       |     |  |
| <b>09 16 000 9908</b>  | 3.4  |                       |   |                  |   |                       |     |                       |     |  |

PCB-Adapter

| Han® 40 A module                                 | Part No.              |                       | Drawing | Dimensions in mm |
|--|-----------------------|-----------------------|---------|------------------|
|  | Male insert (M)       | Female insert (F)     |         |                  |
| <b>Axial screw termination</b><br>Cable side<br> | <b>09 14 002 2601</b> | <b>09 14 002 2701</b> |         |                  |
| <b>PCB adaption</b><br>Device side<br>           | <b>09 14 002 2603</b> | <b>09 14 002 2703</b> |         |                  |
| <b>Solder contact</b><br>                        | <b>09 32 000 6295</b> |                       |         |                  |

- Secondary mating between industrial connector and printed circuit board.
- No higher force is applied on the soldering joint when mating the industrial connector due to an additional mating point.
- No wiring between printed circuit board and industrial connector necessary.
- thus no wiring faults  
⇒ no testing, no costs
- Connecting times are minimized.
- Easy handling is time and cost saving.
- The production of mechanical and electrical / electronical components can be completely separated.
- Possibility to reach a higher degree of automation in the production (i. e. wave soldering of the PCBs).



Han DD® and Han® Q 5/0 PCB adapter  
Wilhelm Fette GmbH, Germany



Han E® PCB adapter

PCB-Adapter

