

### Mini Coax modules (press-in)

Page

Mini Coax connector system – general information . . . . .	<b>07.02</b>
Technical characteristics . . . . .	<b>07.04</b>
Straight Mini Coax Standard modules for backplane assembly . . . . .	<b>07.06</b>
Angled Mini Coax Standard modules for daughtercard assembly . . . . .	<b>07.07</b>
Angled Mini Coax low-profile modules for daughtercard assembly . . . . .	<b>07.08</b>
Angled Mini Coax single-row modules for daughtercard assembly . . . . .	<b>07.09</b>

The Mini Coax connector is a multi line RF connector for blind mating of board-to-board, board-to-cable or cable-to-cable applications. The Mini Coax connector is mainly used in both RF (Radio Frequency) and IF (Intermediate Frequency) signal transmission and is specified for a frequency range from DC to 2.5 GHz and beyond. Thanks to its compact size (a 10 coaxial lines' connector is as small as a PC's enter key) and excellent crosstalk features, this connector system is ideal for high end equipment within cellular telecom infrastructure.

The isolated coaxial lines are implemented in a plastic housing that defines the module size in a metric scale from 1.00, 1.25 and 1.50 SU (SU = System Unit = 25 mm). The Mini Coax connectors are available as straight sockets and right angled plugs. Both types are executed in press-in technology for the PCB (Printed Circuit Board) termination. The straight modules are delivered with an inserted plastic cap that protects the coaxial

contacts against dust and dirt, as well as being used as an upper press-in tool. In this way, an easy and safe flat rock process is guaranteed.

In addition to the coaxial modules, an angled power connector with press-in termination is available. It is assembled in the same board drillings as the coaxial configuration, and can be loaded up to 15 A working current at 70 °C.

The low-profile Mini Coax right angled board connector and matched cable assemblies have the same RF performance as the standard Mini Coax connectors. Their slim interfaces, which provide a board-to-cable solution for the slim cabinet, are suitable for a minimum 15.2 mm slot width.

The Mini Coax single-row is another new development. The coaxial contacts of the connector are single line, as opposed to the standard connector. This delivers enhanced performance, especially in terms of isolation, and is also suitable for slim cabinet applications.

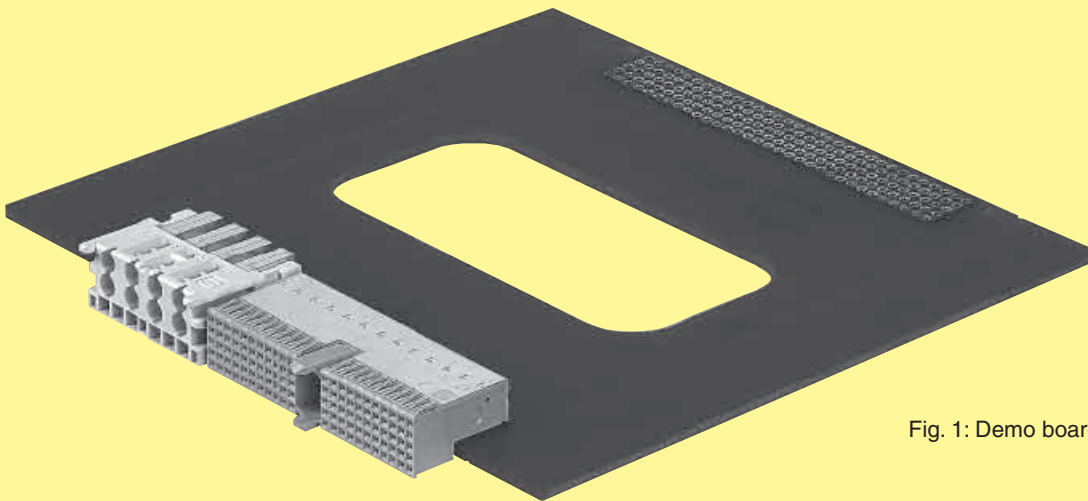

Fig. 1: Demo board

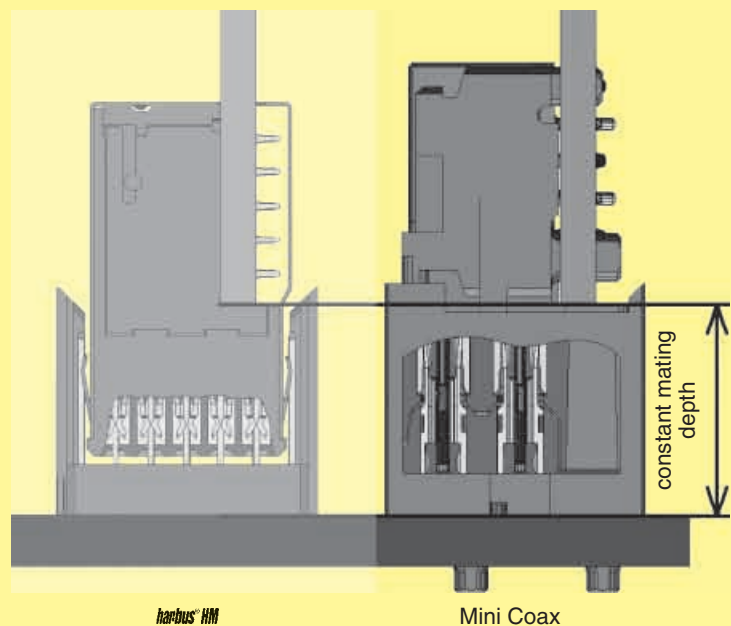

Fig. 2: Cross section of both connector types

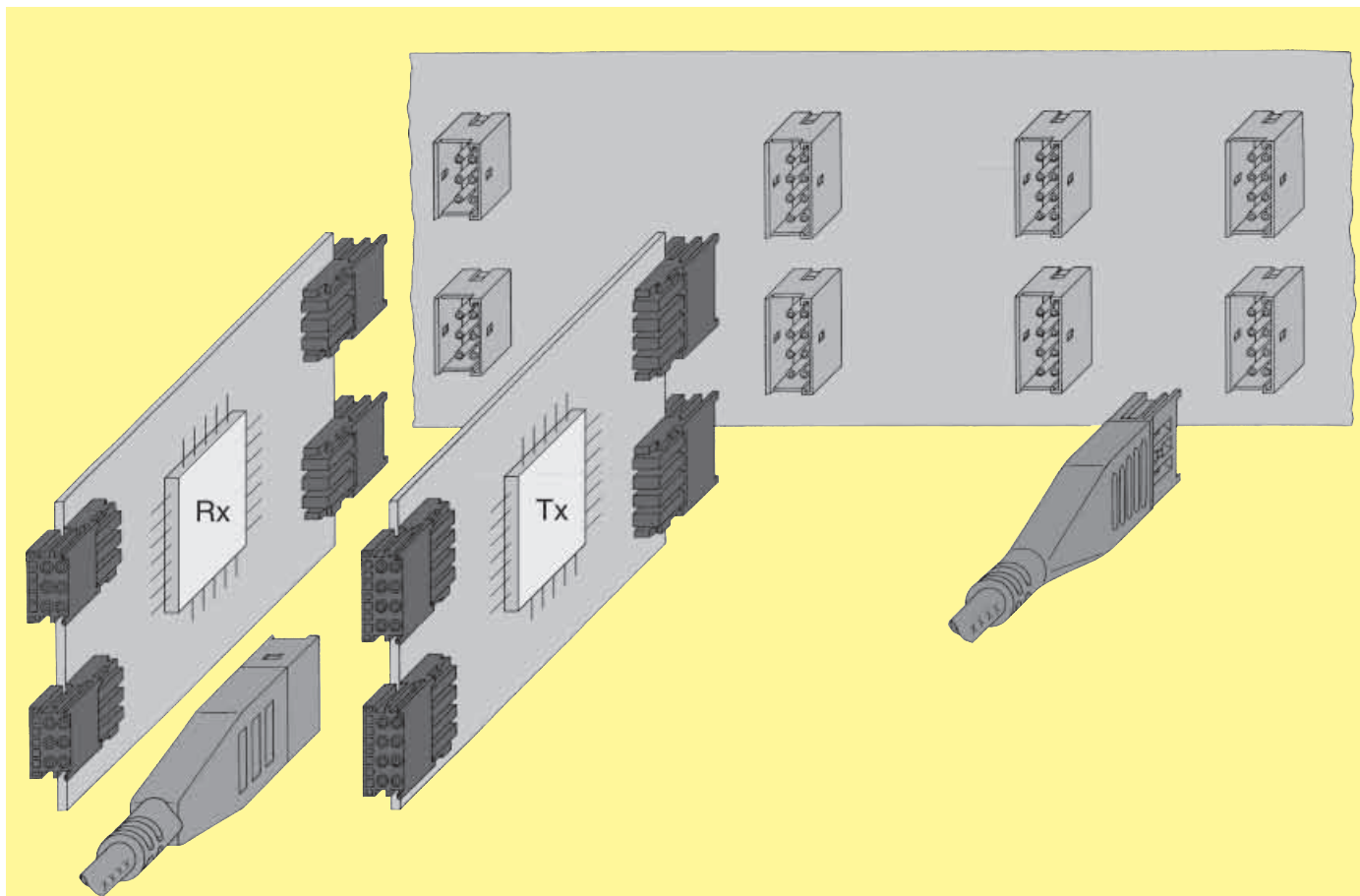

Fig. 3: Typical pcb configurations

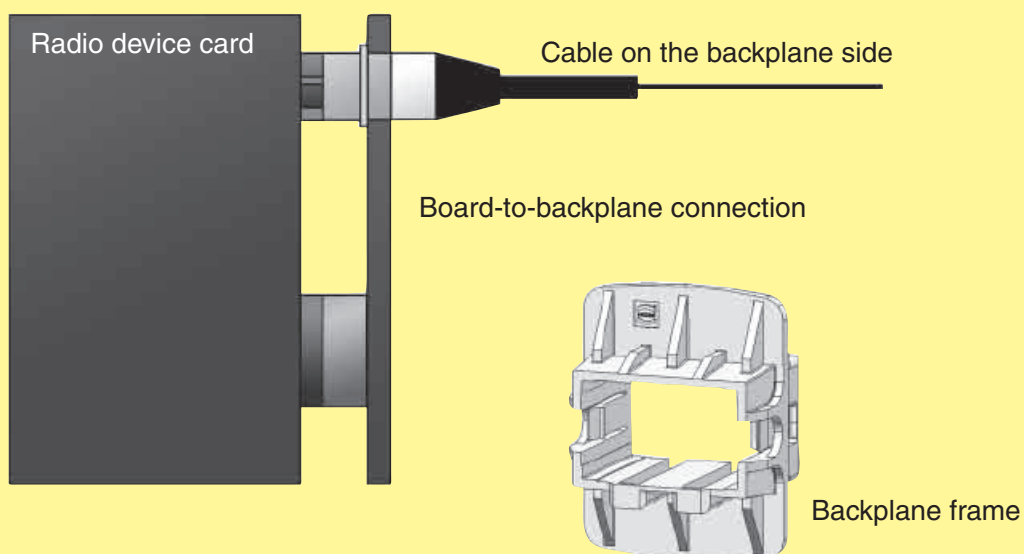

Fig. 4: Mini Coax backplane feed through

Number of contacts : 1, 2, 4, 6, 8 or 10 coaxial contacts  
 Grid pattern : 4.40 x 6.25 mm (within a twin x between twins);  
 8.80 mm for Mini Coax single-row connectors

Dielectric withstanding Voltage  $U_{r.m.s.}$  :  $\leq 1000$  V (for 60 s)  
 DC-contact resistance  
     Centre contact :  $\leq 12$  m $\Omega$   
     Ground contact :  $\leq 6$  m $\Omega$   
 Insulation resistance :  $\geq 5000$  M $\Omega$

Power :  $\leq 40$  W (at 2.5 GHz)  
 Frequency range : DC ... 2.5 GHz  
 Nominal impedance : 50  $\Omega$   
 Return loss :  $< -20$  dB  
 VSWR :  $< 1.22$   
 Insertion loss :  $< 0.25$  dB

Near end crosstalk (NEXT) :	Pin distance	Board-to-Board	Board-to-Cable	Cable-to-Cable
	$\Delta x = 4.40$ mm	50 dB	60 dB	90 dB
	$\Delta x = 6.25$ mm	60 dB	70 dB	90 dB
	$\Delta x = 7.64$ mm	75 dB	80 dB	90 dB
	$\Delta x = 8.80$ mm	–	75 dB	–
	$\Delta x = 12.50$ mm	90 dB	90 dB	90 dB

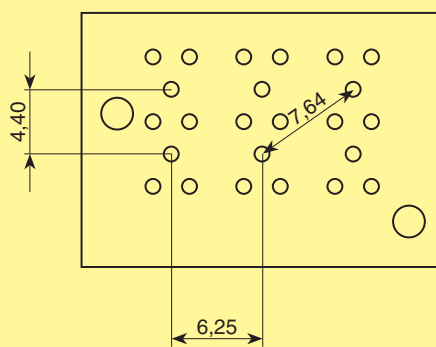

Fig. 5: Grid pattern  
Mini Coax Standard

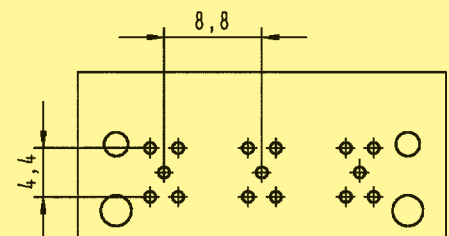

Fig. 6: Grid pattern  
Mini Coax single-row

Temperature range :  $-55$  °C ...  $+125$  °C

Moulding material : Liquid Cristal Polymer (LCP), UL 94-V0

Contact surface  
 Contact zone : Au  
 Termination area  
     Centre pin : Au  
     Ground pin : Ni

Mating cycles : max. 500

Recommended configuration of plated through holes :

<i>Tin plated PCB (HAL)</i> <i>acc. EN 60352-5</i>	Hole-Ø	1.15 <sup>±0.025</sup> mm
	Cu	min. 25 µm
	Sn	max. 15 µm
	Plated hole-Ø	0.94-1.09 mm
<i>Chemical tin plated PCB</i>	Hole-Ø	1.15 <sup>±0.025</sup> mm
	Cu	min. 25 µm
	Sn	min. 0.8 µm
	Plated hole-Ø	1.00-1.10 mm
<i>Au / Ni plated PCB</i>	Hole-Ø	1.15 <sup>±0.025</sup> mm
	Cu	min. 25 µm
	Ni	3-7 µm
	Au	0.05-0.12 µm
	Plated hole-Ø	1.00-1.10 mm
<i>Silver plated PCB</i>	Hole-Ø	1.15 <sup>±0.025</sup> mm
	Cu	min. 25 µm
	Ag	0.1-0.3 µm
	Plated hole-Ø	1.00-1.10 mm
<i>OSP copper plated PCB</i>	Hole-Ø	1.15 <sup>±0.025</sup> mm
	Cu	min. 25 µm
	Plated hole-Ø	1.00-1.10 mm

PCB board thickness: ≥ 1.6 mm

Mating force : ≤ 5 N/line

Withdrawal force : > 1 N/line

Mating distance : 12.5 ... 15 mm

Wiping length : 2.5 mm

Acceptable radial mating offset : max. ± 1.5 mm

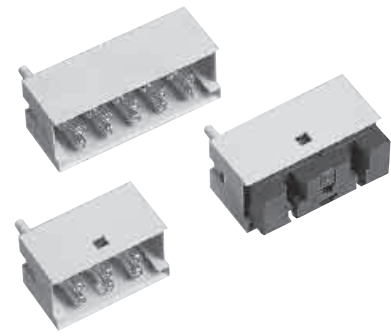

## Straight modules

Identification	Number of contacts	SU	loaded positions	Part number
Mini Coax modules, press-in termination	10	1.50	2, 5, 8, 11, 14	07 11 100 0026
	8	1.25	2, 5, 8, 11	07 11 100 0024
	6	1	2, 5, 8	07 11 100 0023
	4	1	2, 8	07 11 900 0024
	2	1	2	07 11 900 0023

## Dimensions

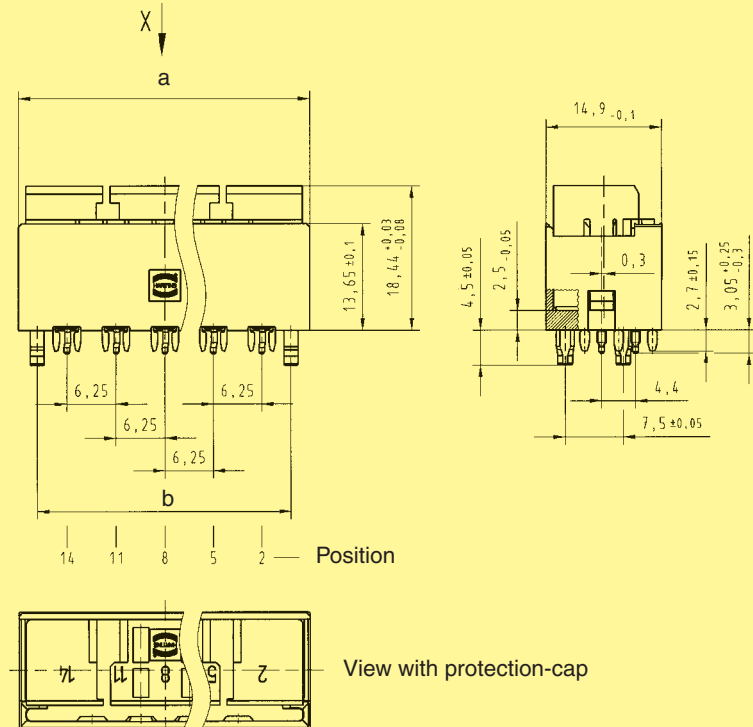

Straight module	Dimension [mm]		
	a	b	c
1.50 SU	37.3	32.5	25
1.25 SU	31.05	26.25	18.75
1.00 SU	24.8	20	12.5

## Board drillings

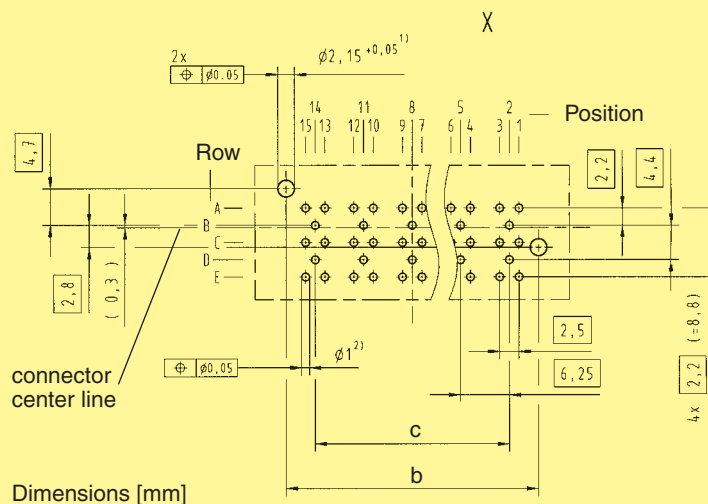

Row B, D: position 2, 5, 8, 11, 14 for signal line  
 Row A, C, E: position 1, 3, 4, 6, 7, 9, 10, 12, 13, 15 for ground-line

1) Non-metallised drillings

2) Details see page 07.05

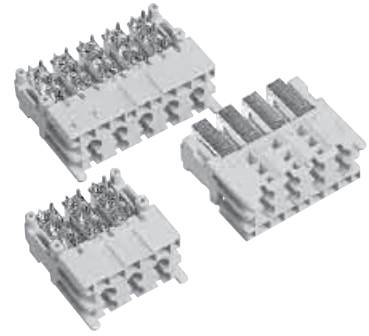

## Angled modules

Identification	Number of contacts	SU	loaded positions	Part number
Mini Coax modules, press-in termination	10	1.50	2, 5, 8, 11, 14	07 31 100 0021
	8	1.25	2, 5, 8, 11	07 31 100 0020
	6	1	2, 5, 8	07 31 100 0019
	4	1	2, 8	07 31 900 0022
	2	1	2	07 31 900 0021

## Dimensions

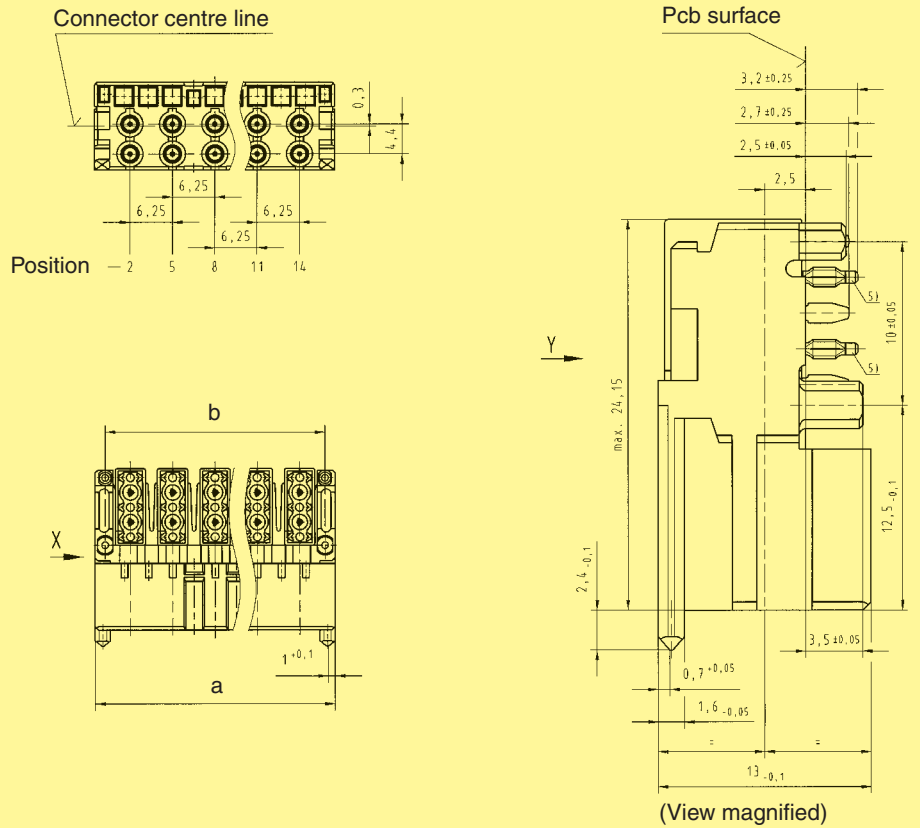

## Board drillings

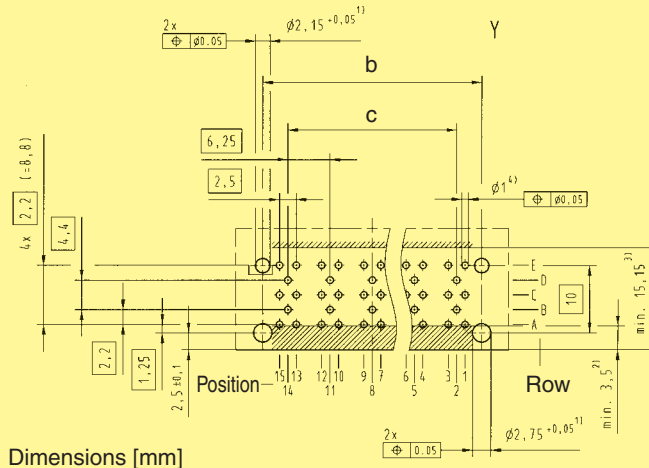

Angled module	Dimension [mm]		
	a	b	c
1.50 SU	35.45	32.5	25
1.25 SU	29.15	26.25	18.75
1.00 SU	22.9	20	12.5

Row B, D: position 2, 5, 8, 11, 14 for signal line  
 Row A, C, E: position 1, 3, 4, 6, 7, 9, 10, 12, 13, 15 for ground-line

- 1) Non-metallised drillings
- 2) No tracks, except solder eyes
- 3) Limit area of components (valid for both pcb-sides)
- 4) Details see page 07.05
- 5) Press-in zone in any angular position related to it's longitudinal axis possible



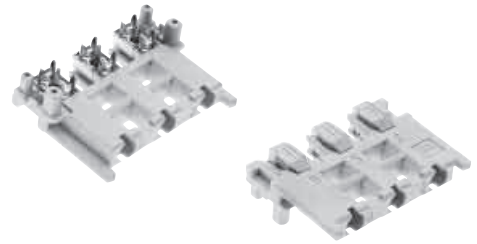

### Angled modules

Identification	Number of contacts	SU	loaded positions	Part number
Mini Coax single-row module, press-in termination	3	1	2, 5, 8	07 31 100 0028

### Dimensions

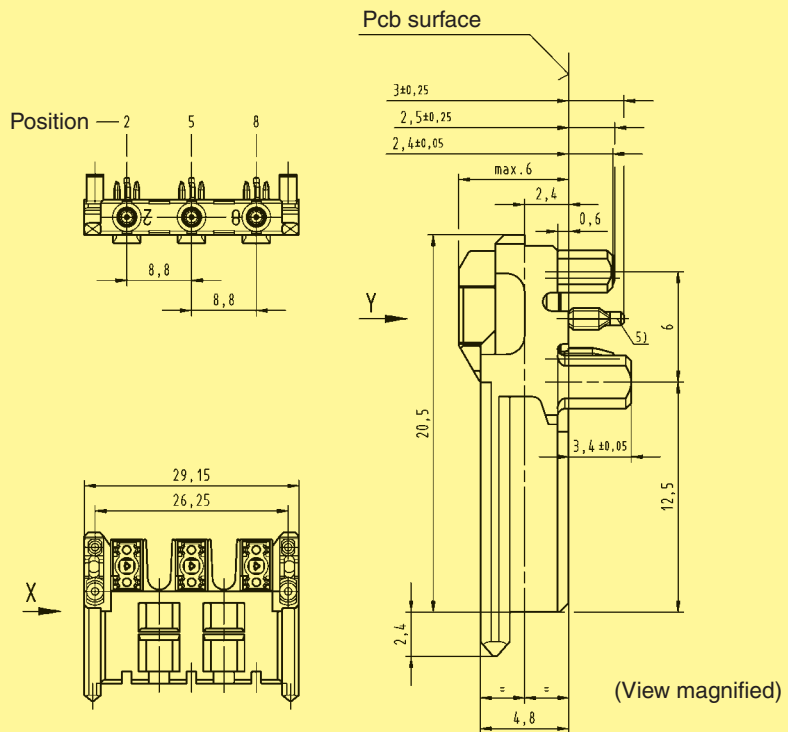

### Board drillings

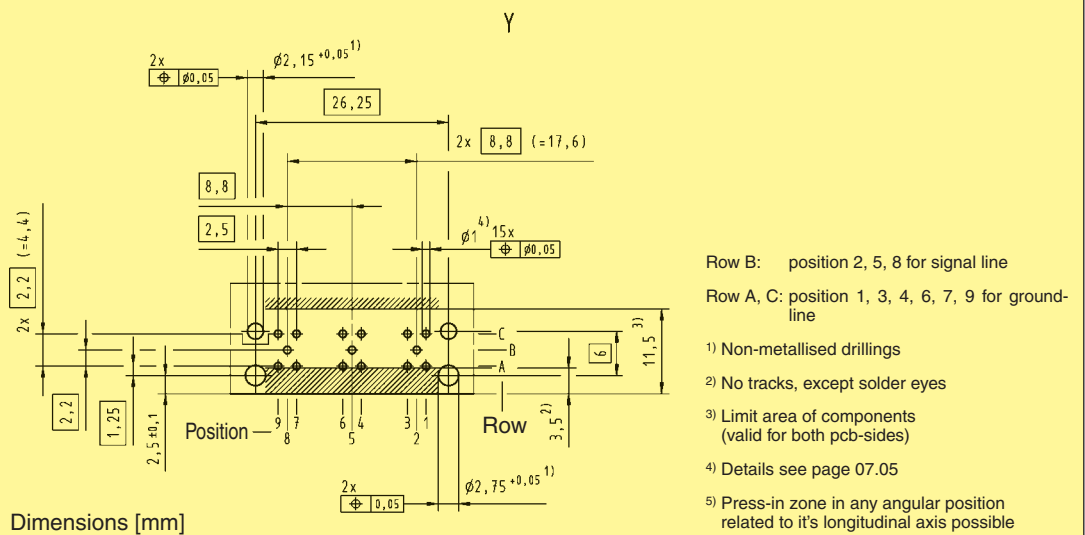

Dimensions [mm]

