

Contents

Page

Features	12.02
Technical characteristics	12.03
Frame	12.04
Accessories	12.04
Plug sockets	12.05
Data connectors	12.07
Wires	12.10
Gender Changer	12.10

Features

- Suitable for rough industrial environments (Degree of protection IP 65 with closed cover)
- Plug sockets for the European and international market
- Standard interfaces for easy connection of devices
- Modular assembly
- Professional design

Termination technology

Gender Changer

- Termination technology pluggable from both sides
- No soldering necessary
- Assembly male/female interchangeable

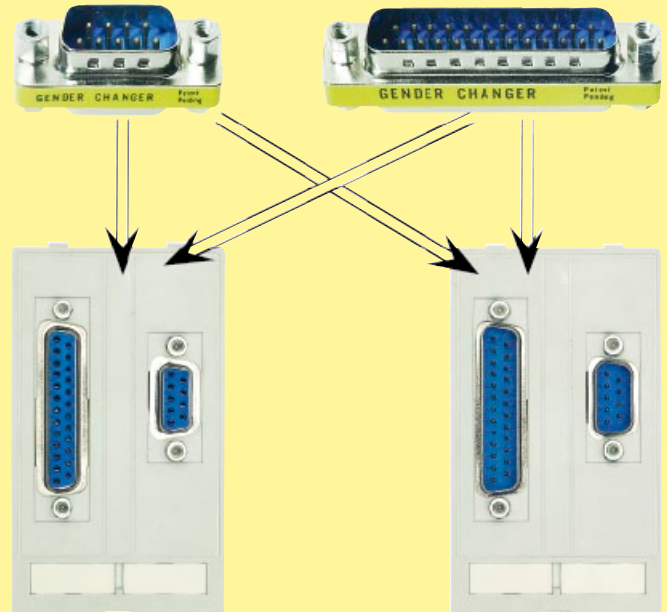

Drawing

Panel cut out (——) for not centred assembly to the outer edge (-----) of the front panel suitable to wall thickness 1 ... 5 mm

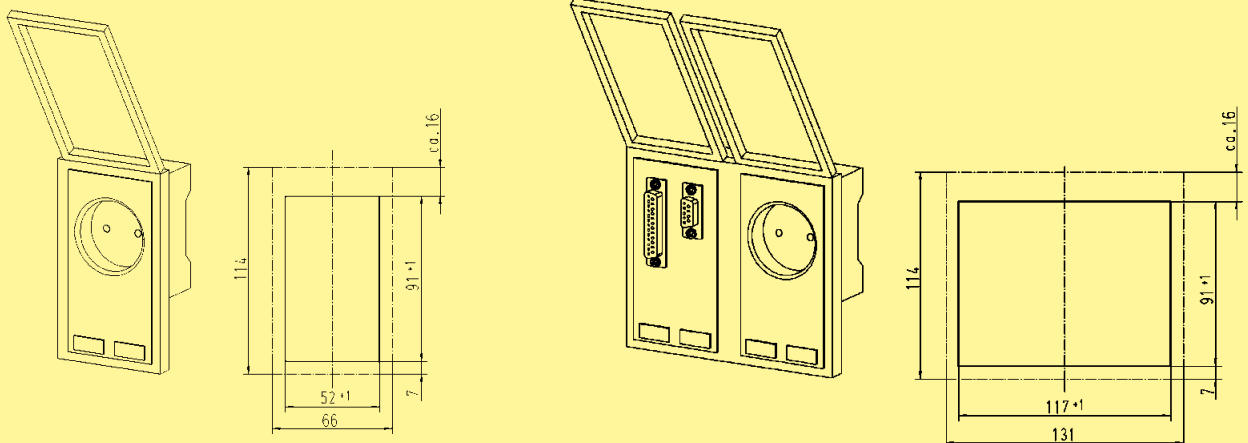

Technical characteristics

Frames

Material	zinc die cast, smouthed surface
Suitable for wall thickness	1 ... 5 mm
Dimensions outside (H x W x D)	single: 114 x 66 x 32 ... 62 mm (depending on equipment) double: 114 x 131 x 32 ... 62 mm (depending on equipment)
Operating temperature range	-10 °C ... +60 °C
Stock temperature range	-25 °C ... +60 °C
Degree of protection	IP 65

Plug sockets

	<u>Germany (VDE)</u>	<u>USA / Euro</u>	<u>USA (NEMA5-15)/ Japan</u>	<u>France (UTE)</u>
Nominal voltage, max.	250 V AC	250 V AC	125 V AC	250 V AC
Nominal frequency	50 Hz AC	60 Hz AC	50 Hz AC	50 Hz AC
Nominal current, max.	10 ... 16 A	15 A	15 A	10 ... 16 A
LED display	Yellow 1)	-	-	Yellow
Termination	Screw terminal	Screw terminal	Screw terminal	Screw terminal
Mounting depth assembled	approx. 62 mm	approx. 30 mm	approx. 30 mm	approx. 62 mm

Plug sockets

	<u>Switzerland</u>	<u>Great Britain (BS)</u>	<u>Italy (CEI 23-16)</u>	<u>Australia / China</u>
Nominal voltage, max.	250 V AC	250 V AC	250 V AC	250 V AC
Nominal frequency	50 Hz AC	50/60 Hz AC	50 Hz AC	50/60 Hz AC
Nominal current, max.	10 A	13 A	10 ... 16 A	10 A
LED display	-	-	-	-
Termination	Spring clamp terminal	Screw terminal	Screw terminal	Screw terminal
Mounting depth assembled	approx. 20 mm	approx. 20 mm	approx. 20 mm	approx. 20 mm

Plug sockets

	<u>Denmark</u>
Nominal voltage, max.	250 V AC
Nominal frequency	50 Hz AC
Nominal current, max.	13 A
LED display	-
Termination	Spring clamp terminal
Mounting depth assembled	approx. 20 mm

Data connectors

	<u>D-Sub</u>	<u>RJ45</u>	<u>USB</u>
Nominal voltage, max.	125 V AC / 150 V DC	50 V AC/DC	30 V AC/DC
Nominal current, max.	3 A	1 A	1 A
Locking	UNC 4-40 bolts	stop bolt	snap-in
Specification	DIN 41 652 / IEC 807	Cat. 5e	size A acc. to 2.0
Mounting depth assembled	approx. 32 mm	approx. 32 mm	approx. 80 mm

Termination

Gender Changer	Termination technology pluggable from both sides
----------------	--

Frame

Part number

Depiction

single

metal version, nickel plated
electrically conductive
IP 65

transparent plastic cover

39 50 000 0100

metal cover

39 50 000 0110

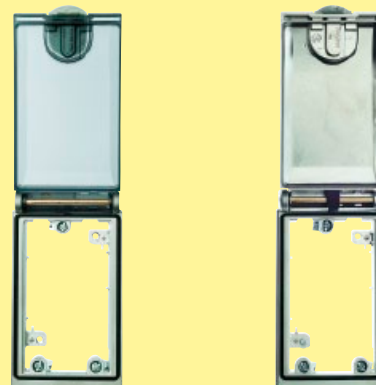

double

metal version, nickel plated
electrically conductive
IP 65

transparent plastic cover

39 50 000 0200

metal cover

39 50 000 0210

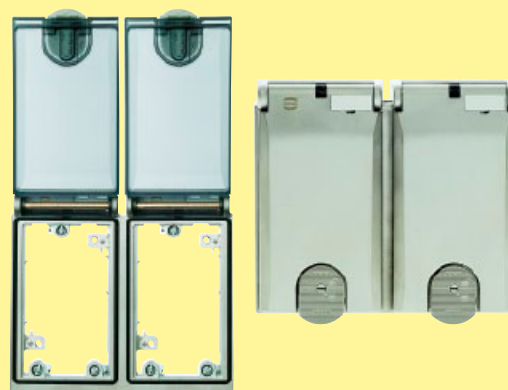

Accessories

Part number

Depiction

Blind plate

free space for self assembly
of connectors or switches
free space: 45 x 75 mm

flat

39 50 000 0890

with perforated cut-out for

Gender Changer RJ45, USB and D-Sub 25

39 50 000 0851

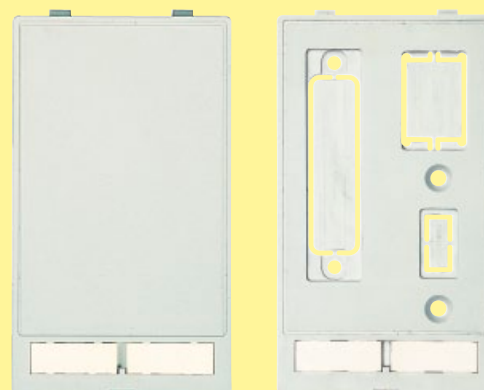

Identification strips

set of 20 pieces

39 50 000 0900



Stock items in bold type

Plug sockets

Part number

Depiction

Germany (VDE)
with LED display
screw terminals for max. 6 mm²
connection at the rear

39 50 001 0001

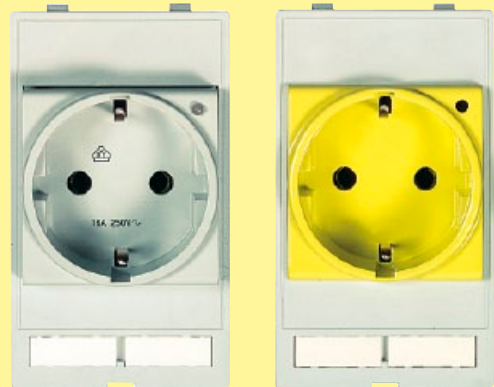

Germany (VDE)
for assembly in front of main switch
flourescent colour yellow (RAL 1016)
without LED display
screw terminals for max. 6 mm²
connection at the rear

39 50 001 0002

USA / Euro
finger protected
screw terminals for max. AWG 14 (2.5 mm²)

39 50 001 0010



USA (NEMA5-15) / Japan
finger protected
screw terminals for max. AWG 14 (2.5 mm²)

39 50 001 0004

France (UTE)
with LED display
screw terminals for max. 6 mm²
connection at the rear

39 50 001 0005



Great Britain (BS)
finger protected
screw terminals for max. 4 mm²

39 50 001 0006



Han-Port

Plug sockets

Part number

Depiction

Italy (CEI 23-16)

double
finger protected
screw terminals for max. 2.5 mm²

39 50 001 0007

Australia / China

screw terminals for max. 2.5 mm²

39 50 001 0009

Denmark

spring clamp terminals for max. 2.5 mm²

39 50 001 0017

Switzerland

spring clamp terminals for max. 1.5 mm²

39 50 001 0012

Data connectors

Part number

Depiction

2x D-Sub 9
2x female/male
Gender Changer
not screened

39 50 003 0020

1x D-Sub 9
1x female/female
Gender Changer
not screened

39 50 003 0024

1x D-Sub 9, D-Sub 25
2x female/male
Gender Changer
not screened

39 50 003 0040

1x D-Sub 25
1x female/male
Gender Changer
not screened

39 50 003 0074

Han-Port

Data connectors

Part number

Depiction

1x RJ45, 2x D-Sub 9
 1x RJ45, 8-pins, metal, Cat. 5e
 female/female, Gender Changer
 1x D-Sub 9
 female/female, Gender Changer
 1x D-Sub 9
 male/male, Gender Changer
 not screened

39 50 003 0111



1x RJ45, D-Sub 9, D-Sub 25
 1x RJ45, 8-pins, metal, Cat. 5e
 female/female, Gender Changer
 1x D-Sub 9
 female/male, Gender Changer
 1x D-Sub 25
 female/male, Gender Changer
 not screened

39 50 003 0170

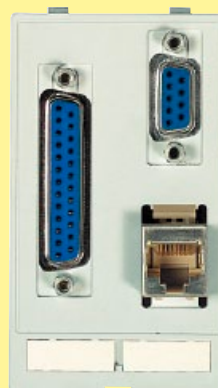

2x USB size A
 2x USB size A acc. to specification 2.0
 female/female, Gender Changer
 screened

39 50 002 0093



2x RJ45
 2x RJ45, 8-pins, metal, Cat. 5e
 female/female, Gender Changer
 screened

39 50 002 0120



Han-Port

Data connectors

Part number

Depiction

1x USB size A, RJ45, D-Sub 9
 1x USB size A acc. to specification 2.0
 female/female, Gender Changer
 1x RJ45, 8-pins, metal, Cat. 5e
 female/female, Gender Changer
 1x D-Sub 9
 female/male, Gender Changer
 screened

39 50 002 0143



1x USB size A, RJ45, D-Sub 25
 1x USB size A acc. to specification 2.0
 female/female, Gender Changer
 1x RJ45, 8-pins, metal, Cat. 5e
 female/female, Gender Changer
 1x D-Sub 25
 female/male, Gender Changer
 screened

39 50 002 0145



1x USB size A, RJ45, 2x D-Sub 9
 1x USB size A acc. to specification 2.0
 female/female, Gender Changer
 1x RJ45, 8-pins, metal, Cat. 5e
 female/female, Gender Changer
 2x D-Sub 9
 male/male, Gender Changer
 screened

39 50 002 0117



Han-Port

Wires

Part number

Depiction

	Length	Termination	
D-Sub 9	2 m	male/male	39 50 903 0010
	5 m	male/male	39 50 903 0011
	2 m	female/male	39 50 903 0020
	5 m	female/male	39 50 903 0021
D-Sub 25	1.8 m	female/male	39 50 903 0040
	5 m	female/male	39 50 903 0041
USB	2 m	USB	39 50 903 0050
	5 m	USB	39 50 903 0051
RJ45	2 m	8-pins, metal, Cat. 5e	39 50 903 0060
	5 m	8-pins, metal, Cat. 5e	39 50 903 0061



Han-Port

Gender Changer

Part number

Depiction

	Termination	
D-Sub 9	female/female	39 50 904 0030
	female/male	39 50 904 0031
	male/male	39 50 904 0032
D-Sub 25	female/female	39 50 904 0050
USB	female/female, size A acc. to specification 2.0	39 50 904 0020
RJ45	female/female, 8-pins, Cat. 5e	39 50 904 0010

